



Expansion of Hong Kong International Airport into a Three-Runway System

Contamination Assessment Report for Terminal 2 Emergency Power Supply Systems No.2, Emergency Power Supply Systems No.3 and Emergency Power Supply Systems No. 5

October 2020

Mott MacDonald
3/F International Trade
Tower
348 Kwun Tong Road
Kwun Tong
Kowloon
Hong Kong

T +852 2828 5757
F +852 2827 1823
mottmac.hk

Airport Authority Hong Kong

Expansion of Hong Kong International Airport into a Three-Runway System

Contamination Assessment Report for
Terminal 2 Emergency Power Supply Systems
No.2, Emergency Power Supply Systems No.3
and Emergency Power Supply Systems No. 5

October 2020

**This Contamination Assessment Report for
Terminal 2 Emergency Power Supply System No.2, Emergency Power
Supply System No.3 and Emergency Power Supply System No.5
has been reviewed and certified by
the Environmental Team Leader (ETL)
In accordance with EP Condition 1.9 of the
Environmental Permit
No. EP-489/2014 and Section 7 of
Supplementary Contamination Assessment Plan (August 2018)**

Certified by:



Terence Kong
Environmental Team Leader (ETL)
Mott MacDonald Hong Kong Limited

Date

30 October 2020

Our Ref : 60440482/C/JCHL201030

By Email

Airport Authority Hong Kong
HKIA Tower, 1 Sky Plaza Road
Hong Kong International Airport
Lantau, Hong Kong

Attn: Mr. Lawrence Tsui, Principal Manager, Environmental Compliance

30 October 2020

Dear Sir,

Contract No. 3102
3RS Independent Environmental Checker Consultancy Services

**Contamination Assessment Report for Terminal 2 Emergency Power Supply Systems No.2,
Emergency Power Supply Systems No.3 and Emergency Power Supply Systems No. 5**

Reference is made to the ET's submission of Contamination Assessment Report for Terminal 2 Emergency Power Supply Systems No.2, Emergency Power Supply Systems No.3 and Emergency Power Supply Systems No. 5 under Section 7 of Supplementary Contamination Assessment Plan and Condition 2.32 (iv) of the Environmental Permit No. EP-489/2014. The subject report was certified by the ET Leader on 30 October 2020.

We would like to inform you that we have no adverse comment on the captioned submission and verify the captioned submission in accordance with the requirement stipulated in Condition 1.9 of EP-489/2014.

Should you have any query, please feel free to contact the undersigned at 3922 9376.

Yours faithfully,
AECOM Asia Co. Ltd.



Jackel Law
Independent Environmental Checker

Contents

1	Introduction	7
1.1	Background	7
1.2	Scope of this CAR	8
1.3	Objective	8
2	Summary of Sampling and Testing Strategy	10
2.1	Proposed Sampling Method in the SCAP	10
2.1.1	Proposed Sampling Method of BH5 and BH6	10
2.2	Alternative Sampling Method Formulated after Pre-demolition Survey	12
2.2.1	Alternative Sampling Method of BH5	12
2.3	Assessment Criteria	12
3	Site Investigation	13
3.1	Sand / Soil Sampling	13
3.1.1	Underground Fuel Tank BH5	13
3.1.2	Underground Fuel Pipeline BH6	13
3.1.3	Additional Photo Record Upon Demolition Works	15
3.2	Decontamination Procedures	15
3.3	Quality Assurance (QA) / Quality Control (QC) Procedure	15
3.3.1	QA/QC Procedure	15
3.3.2	QA/QC Analysis	15
4	Interpretation of Laboratory Testing Results	17
4.1	Sand/Soil Contamination	17
4.1.1	Underground Fuel Tank BH5	17
4.1.2	Underground Fuel Pipeline BH6	18
5	Final Inspection and Record Checking Findings	20
5.1	General	20
5.1.1	Final Inspection and Record Checking Findings	20
6	Conclusion	22

Appendices

A. Updated Implementation Schedule of Land Contamination – Construction Phase

B. Location of Emergency Power Supply System of T2 Building

B.1 Location of Emergency Power Supply Systems of T2 Building (Overview)

- B.2 Location of Emergency Power Supply System No.2 of T2 Building (Zoom-in View of Northern Section of T2 Building)
- B.3 Location of Emergency Power Supply System No.3, Emergency Power Supply System No.4 and Emergency Power Supply System No.5 of T2 Building (Zoom-in View of Southern Section of T2 Building)
- C. Identified Potential Land Contaminated Source of Emergency Power Supply Systems in SCAP
 - C.1 Identified Potential Land Contaminated Source of Emergency Power Supply System No.2 (EPSS2) in SCAP
 - C.2 Identified Potential Land Contaminated Source of Emergency Power Supply System No.3 (EPSS3) in SCAP
 - C.3 Identified Potential Land Contaminated Source of Emergency Power Supply System No.5 (EPSS5) in SCAP
- D. Indicative Sampling Point Selection of 3,000 L Underground Fuel Tank of EPSS3 in SCAP (i.e. BH5)
- E. Indicative Sampling Point of the Underground Pipeline Trench of EPSS3 in SCAP (ie.BH6)
- F. Structure and Actual Sampling Depth of 3,000 L Underground Fuel Tank of EPSS3 (i.e. BH5)
- G. Actual Sampling Point of the Underground Pipeline Trench of EPSS3 (i.e. BH6)
 - G.1 Actual Sampling Point of the Underground Pipeline Trench of EPSS3 (i.e. BH6-S1, BH6-S4, BH6-S5, BH6-S6, BH6-NLTS1)
 - G.2 Site Photo Record of Underground Pipeline Trench of EPSS3 at BH6-S2 and BH6-S3 (Photo Record)
- H. Chain-of-Custody Record
- I. Laboratory Testing Results of BH5 and BH6
- J. Site Photo Record of Final Inspection
 - J.1 Site Photo Record of Final Inspection for EPSS2 BH9 (3000L Above-ground Fuel Tank)
 - J.2 Site Photo Record of Final Inspection for EPSS2 HS1 (2 above-ground Emergency generators)
 - J.3 Site Photo Record of Final Inspection for EPSS3 BH7 (450 L Above-ground Fuel Tank)
 - J.4 Site Photo Record of Final Inspection for EPSS3 BH8 (Above-ground Emergency Generator)
 - J.5 Site Photo Record of Final Inspection for EPSS5 HS4 (Above-ground Fuel Tank) and HS5 (Above-ground Emergency Generator)

1 Introduction

1.1 Background

The Environmental Impact Assessment (EIA) Report (Register No.: AEIAR-185/2014) prepared for the “Expansion of Hong Kong International Airport into a Three-Runway System” (the project) has been approved by the Director of Environmental Protection, and an Environmental Permit (EP) (Permit No.: EP-489/2014) has been issued for the project under the Environmental Impact Assessment Ordinance. As part of the EIA study, a Contamination Assessment Plan (CAP) (hereafter referred to as the Approved CAP) was prepared and presented as Appendix 11.1 of the approved EIA Report. In accordance with Section 8.1.1.1 of the Updated Environmental Monitoring and Audit (EM&A) Manual, which was submitted under Condition 3.1 of the EP, and Section 11.10.1.2 of the EIA Report, six areas (i.e. fuel tank room within Terminal 2 (T2) building, fuel tank room to the west of Civil Aviation Department (CAD) antenna farm, seawater pump house, switching station, pumping station and fire training facility), were inaccessible for site reconnaissance at the time of preparing the EIA Report.

According to Sections 11.5.4.14 and 11.5.4.37 of the EIA Report, it is anticipated that any potential land contamination concern related to possible leakage/ spillage of fuel in the fuel tank room within T2 building and fuel tank room to the west of CAD antenna farm will not cause any insurmountable impact. Furthermore, as mentioned in Sections 11.5.4.38, 11.5.4.47 and 11.5.4.50 of the EIA Report, the seawater pump house, switching station, pumping station and fire training facility are not identified as potential contaminative land use types as given in Table 2.3 of the Practice Guide for Investigation and Remediation of Contaminated Land, hence no potential land contamination along these areas are anticipated.

As part of the ongoing detailed design of the project, relocation of the switching station is no longer required for the modification of existing North Runway. Hence site appraisal process for land contamination potential at the switching station is considered not necessary. Further site reconnaissance was conducted at the remaining five assessment areas (i.e. the fuel tank room within T2 building, fuel tank room to the west of CAD antenna farm, seawater pump house, pumping station and fire training facility) in third quarter of 2016 and May 2017.

Further review on the as-built drawings when taking into account the latest design details of T2 Expansion project and planned site investigation (SI), as well as follow-up site reconnaissance at T2 building have been undertaken in January 2018 and February 2018 (i.e. fuel tanks and generators within the building). Findings and consideration of assessment results after EIA stage have been summarized in the Supplementary Contamination Assessment Plan (SCAP) being approved in August 2018.

Based on the latest construction programme, decommissioning/ demolition of the Emergency Power Supply Systems No.2 (hereafter referred as EPSS2), Emergency Power Supply Systems No.3 (hereafter referred as EPSS3) and Emergency Power Supply Systems No. 5 (hereafter referred as EPSS5) of T2 building is scheduled to commence in 2nd Quarter of 2020.

Mott MacDonald Hong Kong Limited (MMHK), as the project’s Environmental Team, was appointed by Airport Authority Hong Kong (AAHK) to prepare the Contamination Assessment Report (CAR) for Terminal 2 EPSS2, EPSS3 and EPSS5 to fulfil part of the SCAP’s recommendation as this CAR only covers three concerned areas. The updated Implementation Schedule of Land Contamination – Construction Phase is provided in **Appendix A**.

1.2 Scope of this CAR

T2 building of the Hong Kong International Airport comprises northern and southern sections, where each section consists of a number of Emergency Generator Rooms and Fuel Tank Rooms.

The EPSS2 was located at northern section of T2 Building, the set of emergency power supply system comprises above-ground section only. Whereas EPSS3 and EPSS5 were located at southern section of T2 Building. The EPSS3 comprises underground and above-ground section; and for EPSS5, the system comprises above-ground section only.

The locations of the captioned emergency power supply systems are shown in **Appendix B**. The identified potential land contamination sources are listed in **Table 1.1** below,

Table 1.1: Identified Potential Land Contamination Source of Emergency Power Supply Systems

Emergency Power Supply System	Potential Land Contamination Source Reference ID	Description	Location	
Northern Section				
Emergency Power Supply System No.2	Above-ground Section		Please refer to Appendix C	
	BH9	A 3,000 L above-ground fuel tank at Fuel Tank Room		
HS1	Two emergency generators at Emergency Generator Room, connecting to the 3,000 L above-ground fuel tank (i.e. BH9)			
Southern Section				
Emergency Power Supply System No.3	Underground Section			
	BH5	A 3,000 L underground fuel tank		
	BH6	26 m in-length underground fuel pipelines connecting the 3,000 L underground fuel tank (i.e. BH5) and the 450 L above-ground fuel tank (i.e. BH7)		
	Above-ground Section			
	BH7	A 450 L above-ground fuel tank at Emergency Generator Room		
	BH8	An emergency generator at Emergency Generator Room, connecting to the 450 L above-ground tank (i.e. BH7)		
Emergency Power Supply System No.5	Above-ground Section			
	HS4	A 1,500 L above-ground fuel tank at Fuel Tank Room		
	HS5	An emergency generator at Emergency Generator Room, connecting to the 1,500 L above-ground fuel tank (i.e. HS4)		

Layout plans of respective emergency power supply systems included in this CAR are presented in **Appendix C**.

1.3 Objective

According to the approved SCAP, for the above-ground sections including BH7, BH8, BH9, HS1, HS4 and HS5, final inspection and record checking shall be conducted right before decommissioning/ demolition. While for the underground section including BH5 and BH6, enhanced SI programme shall be conducted along with decommissioning/demolition to confirm no potential land contamination taken place.

For the above-ground sections, decommissioning/ demolition works were scheduled in the 2nd Quarter of 2020. Final site inspections and record checking were conducted according to the decommissioning/ demolition schedule of respective Emergency Power Supply Systems. Photo records and findings have been included in this CAR. For underground sections, enhanced SI programme for BH5 and BH6 was carried out between June and August 2020.

This CAR for has been prepared to present the findings of final inspections and record checking of the above-ground sections (i.e. BH7, BH8, BH9, HS1, HS4 and HS5), as well as the sampling procedures and laboratory

testing of enhanced SI for the underground sections (BH5 and BH6) as described in **Section 1.2**. Testing results have been interpreted based on the Guidance Manual for Use of Risk Based Remediation Goals (RBRGs) for Contaminated Land Management (Guidance Manual) and detailed in **Section 4**.

2 Summary of Sampling and Testing Strategy

2.1 Proposed Sampling Method in the SCAP

2.1.1 Proposed Sampling Method of BH5 and BH6

According to the SCAP, grab sampling was proposed for the concerned underground facilities of T2 Building, including BH5 and BH6. The proposed sampling and testing plan including the parameters to be tested, sampling locations and sampling depths are presented in **Table 2.1**. Sand and soil samples should be grabbed manually during the decommissioning/demolition process of concerned fuel tanks (i.e. BH5) and underground pipeline trench (i.e. BH6). The whole sampling process should be under the supervision of on-site contamination specialist.

Sampling Selection of Underground Fuel Tank (i.e. BH5)

Sand and soil samples should be collected as follows:

- Sand samples should be collected at 0.5 m, 1.5 m and bottom level inside the concrete chamber of underground fuel tank; and
- Soil sample should be collected right underneath concrete chamber of underground fuel tank.

Sampling Selection of Underground Fuel Pipeline (i.e. BH6)

Sand and soil samples should be collected as follows:

- Sand samples should be taken at every curvature of pipeline inside the concrete trench;
- Additional sampling points inside the concrete trench are set depending on length of pipeline segment (from curvature/connection to curvature):
 - If pipeline segment is ≤ 10 m, additional sample is considered not required;
 - If pipeline segment is > 10 m and ≤ 20 m, one sample shall be taken at segment mid-point;
 - If pipeline segment is > 20 m and ≤ 30 m, samples shall be collected at 2 points which are evenly spaced with each other and segment ends.
- Soil samples should be taken right underneath concrete trench at every curvature.

Sampling point annotation and indicative sampling point locations of BH5 and BH6 extracted from the SCAP are presented in **Table 2.2, Appendix D and Appendix E**.

Table 2.1: Enhanced Sampling and Testing Plan for BH5 and BH6 of Emergency Power Supply System No.3 in T2 Building

Proposed Sampling Locations	Sample Matrix		Sampling Point Annotation	Parameters to be Tested ^{1 & 2}			Rationale of Sampling	
				Heavy Metals	PCRs ³	VOCs ³		SVOCs ³
BH5 ⁴	Sand ⁵	0.5 m, 1.5 m bgs ⁶ and bottom level / inside the concrete chamber	/	Lead only	✓	BTEX ⁷ and MTBE ⁸	PAHs ⁹	Confirm no diesel leakage from underground fuel tank
	Soil	Right underneath concrete chamber	/	Lead only	✓	BTEX ⁷ and MTBE ⁸	PAHs ⁹	Confirm no leaked diesel (if any) penetrate the concrete chamber
BH6 ⁴	Sand ⁵	At the level of fuel pipelines	BH6S1 - BH6S4	Lead only	✓	BTEX ⁷ and MTBE ⁸	PAHs ⁹	Confirm no diesel leakage from underground fuel pipelines
	Soil	Right underneath concrete/brick trench	BH6S1, BH6S4	Lead only	✓	BTEX ⁷ and MTBE ⁸	PAHs ⁹	Confirm no leaked diesel (if any) penetrate the concrete /brick trench

Remarks:

¹ ✓ = testing proposed.

² Having reviewed the potentially polluting activities of the site (use of diesel fuel) and S2.4.3 of Practice Guide, it is recommended to analyse the key COCs (i.e. Lead, PCRs, BTEX, MTBE and PAHs) of "Petrol Filling Station" which is the most relevant land use type for the case of T2. The concerned diesel tanks and pipelines are used for storage and transfer of diesel fuel only and only diesel fuel is used for the generator. It is noted BTEX, MTBE and Lead present in gasoline but unlikely to be found in diesel fuel.

³ PCRs = Petroleum Carbon Ranges; VOCs = Volatile Organic Chemicals; SVOCs = Semi-volatile Organic Chemicals;

⁴ Exact sampling locations will be identified on site during the removal of sand/soil during fuel tank and pipelines decommissioning/ demolition.

⁵ All sand samples will be collected within the concrete chamber or concrete/brick trench.

⁶ bgs = Below Ground Surface.

⁷ BTEX = Benzene, Toluene, Ethylbenzene, and Xylenes.

⁸ MTBE = Methyl Tert-Butyl Ether.

⁹ Polyaromatic hydrocarbons (PAHs) in the RBRGs include, acenaphthene, acenaphthylene, anthracene, benzo(a)anthracene, benzo(a)pyrene, benzo(b)fluoranthene, benzo(g,h,i)perylene, benzo(k)fluoranthene, chrysene, dibenzo(a,h)anthracene, fluoranthene, fluorene, indeno(1,2,3-cd)pyrene, naphthalene, phenanthrene and pyrene.

Table 2.2: Sampling Point Annotation of Underground Fuel Pipeline BH6

Sampling Locations	Sampling Point	Type of Sampling Point (Curvature/ Additional)	Figure No.
BH6	BH6-S1	Curvature	Appendix E
	BH6-S2	Additional	
	BH6-S3	Additional	
	BH6-S4	Curvature	

2.2 Alternative Sampling Method Formulated after Pre-demolition Survey

2.2.1 Alternative Sampling Method of BH5

With the sampling experience of BH1 (for Emergency Power Supply System No.1), deviation between as-built drawing and the actual concrete chamber is expected. It is expected that the fuel tank is fully encased in the concrete chamber. However, the top concrete slab would be located at an uncertain level which would be beneath the surface ground and above the fuel tank. In consideration of the actual site condition and safety reasons, borehole sampling for BH5 was proposed by the Contractor, instead of grab sampling as proposed in the SCAP. Discussion was held between amongst the Contractor, AAHK and the land contamination specialist. It was agreed with the land contamination specialist that the borehole would be undertaken by means of rotary drilling method.

Details of sampling depths was presented in **Section 3.1**.

2.3 Assessment Criteria

The chemicals of concern (COCs) listed in EPD's Guidance Manual for Use of Risk-Based Remediation Goals for Contaminated Land Management were referred to when proposing the analytical parameters listed in **Table 2.1**. According to Section 5.3 of the SCAP, categories of Industrial were adopted for evaluating the contamination level of T2 building.

3 Site Investigation

3.1 Sand / Soil Sampling

3.1.1 Underground Fuel Tank BH5

Site investigation works of BH5 was commenced on 29 June 2020 by DriITech Ground Engineering Limited. Samples were collected at the level of 0.5m and 1.5m below the top slab of the concrete chamber. However, the borehole drill coring process encountered a hard structure when it reached 1.9m below the top concrete slab. In view of the deviation between as-built drawing and the on-site observation, and with the consideration of incurred safety risk, the sampling by rotary drilling method was temporary stopped.

To confirm with the structure encountered at 1.9m below the top concrete slab, an inspection pit was excavated down to 1.9m below ground surface. An inspection was conducted by the land contamination specialist on 24 July 2020. It was found that there was a second concrete slab inside the concrete chamber and the fuel tank was still fully encased in a at least 300 mm thick concrete chamber, with the top concrete slab right beneath the surface ground level and the second concrete slab located at around 1.9 m below the top concrete slab. The structure is illustrated in **Appendix F**.

Another site investigation was conducted by land contamination specialist on 20 August 2020. It was found that the lower concrete chamber encasing the fuel tank with an inner depth of 1.25m, with 0.7m void right underneath the second concrete slab. A depth of 0.55m sand was filled from the bottom of the second concrete chamber. Since the actual inner depth of concrete chamber is smaller than those shown in the as-built drawing, as decided by the land contamination specialist, it was considered that 1 undisturbed sand samples collected at 1.0m below the second concrete slab of the concrete chamber was adequate and representative to confirm whether there was land contamination impact caused by the underground fuel tank.

One undisturbed soil sample was collected at 0.5m underneath the bottom concrete slab of the concrete chamber. The entire SI programme was supervised by the land contamination specialist. The actual sampling depths are summarized in **Table 3.1** and illustrated in **Appendix F**. All soil/sand samples were analyzed in accordance with the testing schedules detailed in **Table 2.1**.

No ground water was observed during sand and soil sampling work of BH5.

Table 3.1: Summary of Sampling Depth of BH5

Sampling Locations	Sampling Depth	Sampling Date
BH5	0.5m below the top concrete slab of the concrete chamber	29 June 2020
	1.5m below the top concrete slab of the concrete chamber	29 June 2020
	1.0m below the second concrete slab of the concrete chamber	20 August 2020
	0.5m underneath the bottom concrete slab of the concrete chamber	20 August 2020

3.1.2 Underground Fuel Pipeline BH6

Soil sampling of BH6 segments was carried out by land contamination specialist on 24 July 2020. Soil samples were collected at sampling points BH6-S1, BH6-S4, BH6-S5, BH6-S6 and BH6-NLTS1. According to site observation, a segment of underground pipeline with 1.3m in length located between BH5 and BH6-S6 are not laid inside the concrete trench, while the underground pipeline running from BH6-S6 to BH7 is laid inside the concrete trench. The actual sampling points and on-site length measurement of the segments of underground pipeline BH6 are illustrated in **Appendix G**.

BH6 segment between sampling point BH6-S6 and BH7

Based on-site observation, it was found that the concrete trench was filled with concrete rather than sand and no sand samples could be collected inside the concrete trench. Therefore, soil samples were collected at the following sampling points at the depth right underneath the concrete trench, where the curvature of the pipelines located,

- BH6-S1 (Same sampling point proposed in SCAP);
- BH6-S4 (Same sampling point proposed in SCAP);
- BH6-S5 (Newly added according to on-site condition); and
- BH6-S6 (Newly added according to on-site condition).

For indicative sampling points, BH6-S2 and BH6-S3, as no sand samples could be collected at the level of fuel pipelines, the site condition of the concrete trench was examined on-site and the observations are presented in **Appendix G**. No cracks on the concrete-trench nor oil stains were found in the vicinity of these 2 sampling points. However, due to the safety concerns of excavation at the time of on-site inspection, site photos at the sides and bottom of BH6-S2 and BH6-S3 could not be taken on 24 July 2020. However, with consideration of the site observations as presented in **Appendix G** and the laboratory testing results of BH6-S1 and BH6-S4, which are at the same segment and near in location, it is confirmed that no diesel leakage from the underground fuel pipelines laid in concrete trench.

To err on a conservative side, additional site photo records at BH6-S2 and BH6-S3 will be provided to EPD after the pipeline at BH6-S2 and BH6-S3 was removed.

No ground water was observed during soil sampling work of BH6-S1, BH6-S4, BH6-S5 and BH6-S6.

BH6 segment between BH5 and sampling point BH6-S6 (No-concrete-trench segment)

To confirm no diesel leakage from underground fuel pipelines from the 1.3m in length no-concrete-trench segment, 1 soil sample was taken right underneath the particular segment (i.e. BH6-NLTS1). Having considered that the sampling point selection strategy in the SCAP (i.e. If pipeline segment is ≤ 10 m, an additional sample is considered not required), the site observations where no oil stains being found in the vicinity of BH6-NLTS1, and the laboratory testing result for BH6-S6 (no contamination was found) which is near to the location of BH6-NLTS1, 1 sample collected at the depth right underneath the pipeline was deemed to be sufficient to represent and confirm if any diesel leakage from the 1.3m long (as revealed on-site) of no-concrete-trench segment.

No ground water was observed during soil sampling work of BH6-NLTS1.

The actual sampling points and on-site length measurement of the particular segment of underground pipeline BH6 are summarized in **Table 3.2** and illustrated in **Appendix G**. All soil samples were analyzed in accordance with the analysis schedules detailed in **Table 2.1**.

Table 3.2: Summary of Sampling Point of BH6

Sampling Locations	Sampling Point	Type of Sampling Point (Curvature/ Additional/ No-concrete-trench Segment)	Sampling Date
BH6	BH6-NLTS1	No-concrete-trench Segment	24 July 2020
	BH6-S1	Curvature	24 July 2020
	BH6-S4	Curvature	24 July 2020
	BH6-S5	Curvature	24 July 2020
	BH6-S6	Curvature	24 July 2020

3.1.3 Additional Photo Record Upon Demolition Works

To err on a conservative side, additional site photo records at the sides and bottom of BH6-S2 and BH6-S3 will be submitted to EPD upon the demolition work at these locations to reaffirm the conclusion drawn in **Section 3.1.2** that there was no diesel leakage from the underground fuel pipe.

In case that sign of diesel leakage is spotted during the demolition works, agreement from EPD shall be sought for sampling strategy and subsequent SI shall be arranged in accordance with the agreed sampling plan. A CAR should be submitted to EPD and if remediation is required, a Remediation Action Plan and Remediation Report will also be prepared.

3.2 Decontamination Procedures

Before excavation/ sampling, all equipment in contact with the ground were thoroughly decontaminated between each excavation and sampling event to minimise the potential for cross contamination. The equipment should be decontaminated by steam cleaning or high-pressure hot water jet, then washed by phosphate-free detergent and finally rinsed by distilled water. During decontamination procedures and sampling, disposable latex gloves were worn to prevent the transfer of contaminants from other sources.

3.3 Quality Assurance (QA) / Quality Control (QC) Procedure

3.3.1 QA/QC Procedure

The soil samples taken were placed in sample containers provided by the HOKLAS laboratory. Sufficient sample size was collected for the laboratory analysis. Samples were marked with sampling date, sampling identification number and sampling depth with appropriate chain-of-custody form. Collected samples were then stored in a cool box at a temperature between 0°C and 4°C and transported to the laboratory immediately after completion of the sampling.

The chain-of-custody records are given in **Appendix H**.

3.3.2 QA/QC Analysis

In this enhanced SI programme, QA/QC samples were collected in accordance with the frequency proposed in the SCAP as follows, with a Chain of Custody protocol adopted:

- One equipment blank per 20 samples for full suite analysis*;
- One field blank per 20 samples for full suite analysis*;
- One duplicate sample per 20 samples for full suite analysis*; and
- One trip blank per trip for the analysis of volatile parameters#.

Note:

* For the purposes of this enhanced SI programme, the following parameters were tested in a 'full suite analysis' –

- Heavy Metals: Lead only.
- PCRs: C6-C8; C9-C16; C17-C35.
- VOCs: Benzene, Toluene, Ethylbenzene, Xylenes and Methyl Tert-Butyl Ether.
- SVOCs: acenaphthene, acenaphthylene, anthracene, benzo(a)anthracene, benzo(a)pyrene, benzo(b)fluoranthene, benzo(g,h,i)perylene, benzo(k)fluoranthene, chrysene, dibenzo(a,h)anthracene, fluoranthene, fluorene, indeno(1,2,3-cd)pyrene, naphthalene, phenanthrene and pyrene.

For the purposes of this Project, the following parameters were tested in the analysis of 'volatile parameters' – Benzene, Toluene, Ethylbenzene, Xylenes, Methyl Tert-Butyl Ether and C6-C8.

The duplicate, equipment blank and field blank samples were collected on 29 June 2020 during the sampling for BH5.

The laboratory results for QA/QC samples are presented in **Appendix I**.

All testing parameters were not detected (below the limit of reporting) in all blank samples obtained, except Total Petroleum Hydrocarbons (TPH) C17 – C35 of equipment blank is in mild detected level. Given that the same testing parameters (C17 – C35) in the sand and soil samples are below the limit of reporting, therefore, it is considered that the testing results of sand and soil samples are reliable. QA/QC procedures for sample collection and preparation are considered acceptable.

4 Interpretation of Laboratory Testing Results

4.1 Sand/Soil Contamination

4.1.1 Underground Fuel Tank BH5

A total of 3 sand samples and 1 soil sample were collected at BH5 for laboratory testing. The testing results are summarised in **Table 4.1** and the testing reports are presented in **Appendix I**. The testing results of all parameters indicated that all sand/ soil samples from BH5 were below the value of RBRGs for Industrial.

Table 4.1: Laboratory Testing Results of Sand and Soil Samples at BH5

Chemical	Concentration (mg/kg)				BH5 RBRGs for Industrial
	BH5 (0.5 m below the top concrete slab of the concrete chamber)	BH5 (1.5 m below the top concrete slab of the concrete chamber)	BH5 (1.0m below the second concrete slab of the concrete chamber)	BH5 (0.5m underneath the bottom concrete slab of the concrete chamber)	
Heavy Metals					
Lead	8	7	4	7	2290
PCRs					
C6 - C8	<5	<5	<5	<5	C6 - C8: 10,000
C9 - C16	<200	<200	<200	<200	C9 - C16: 10,000
C17 - C35	<500	<500	<500	<500	C17 - C35: 10,000
VOCs					
Benzene	<0.2	<0.2	<0.2	<0.2	9.21
Toluene	<0.5	<0.5	<0.5	<0.5	10,000
Ethylbenzene	<0.5	<0.5	<0.5	<0.5	8,240
Xylenes (Total)	<2.0	<2.0	<2.0	<2.0	1,230
Methyl tert-Butyl Ether	<0.2	<0.2	<0.2	<0.2	70.1
SVOCs					
Naphthalene	<0.500	<0.500	<0.500	<0.500	453
Acenaphthylene	<0.500	<0.500	<0.500	<0.500	10,000
Acenaphthene	<0.500	<0.500	<0.500	<0.500	10,000
Fluorene	<0.500	<0.500	<0.500	<0.500	10,000
Phenanthrene	<0.500	<0.500	<0.500	<0.500	10,000
Anthracene	<0.500	<0.500	<0.500	<0.500	10,000
Fluoranthene	<0.500	<0.500	<0.500	<0.500	10,000
Pyrene	<0.500	<0.500	<0.500	<0.500	10,000
Benz(a)anthracene	<0.500	<0.500	<0.500	<0.500	91.8
Chrysene	<0.500	<0.500	<0.500	<0.500	1140
Benzo(b)fluoranthene	<0.500	<0.500	<0.500	<0.500	17.8
Benzo(k)fluoranthene	<0.500	<0.500	<0.500	<0.500	918
Benzo(a)pyrene	<0.500	<0.500	<0.500	<0.500	9.18
Indeno(1.2.3.cd)pyrene	<0.500	<0.500	<0.500	<0.500	91.8
Dibenz(a,h)anthracene	<0.500	<0.500	<0.500	<0.500	9.18
Benzo(g,h,i)perylene	<0.500	<0.500	<0.500	<0.500	10,000

4.1.2 Underground Fuel Pipeline BH6

A total of 5 soil samples were collected at BH6 for laboratory testing. The testing results are summarised in **Table 4.2** and the testing reports are presented in **Appendix I**. The testing results of all parameters indicated that all soil samples from BH6 were below the value of RBRGs for Industrial.

Contamination Assessment Report for
Terminal 2 Emergency Power Supply Systems No.2, Emergency Power Supply Systems No.3 and Emergency Power Supply Systems No. 5

Table 4.2: Laboratory Testing Results of Soil Samples at BH6

Compound	Concentration (mg/kg)					
	BH6-NLTS1	BH6-S1	BH6-S4	BH6-S5	BH6-S6	RBRGs for Industrial
Heavy Metals						
Lead	62	76	209	71	104	2290
PCRs						
C6 - C8	<5	<5	<5	<5	<5	C6 - C8: 10,000
C9 - C16	<200	<200	<200	<200	<200	C9 - C16: 10,000
C17 - C35	<500	<500	<500	<500	<500	C17 - C35: 10,000
VOCs						
Benzene	<0.2	<0.2	<0.2	<0.2	<0.2	9.21
Toluene	<0.5	<0.5	<0.5	<0.5	<0.5	10,000
Ethylbenzene	<0.5	<0.5	<0.5	<0.5	<0.5	8,240
Xylenes (Total)	<2.0	<2.0	<2.0	<2.0	<2.0	1,230
Methyl tert-Butyl Ether	<0.2	<0.2	<0.2	<0.2	<0.2	70.1
SVOCs						
Naphthalene	<0.500	<0.500	<0.500	<0.500	<0.500	453
Acenaphthylene	<0.500	<0.500	<0.500	<0.500	<0.500	10,000
Acenaphthene	<0.500	<0.500	<0.500	<0.500	<0.500	10,000
Fluorene	<0.500	<0.500	<0.500	<0.500	<0.500	10,000
Phenanthrene	<0.500	<0.500	<0.500	<0.500	<0.500	10,000
Anthracene	<0.500	<0.500	<0.500	<0.500	<0.500	10,000
Fluoranthene	<0.500	<0.500	<0.500	<0.500	<0.500	10,000
Pyrene	<0.500	<0.500	<0.500	<0.500	<0.500	10,000
Benz(a)anthracene	<0.500	<0.500	<0.500	<0.500	<0.500	91.8
Chrysene	<0.500	<0.500	<0.500	<0.500	<0.500	1140
Benzo(b)fluoranthene	<0.500	<0.500	<0.500	<0.500	<0.500	17.8
Benzo(k)fluoranthene	<0.500	<0.500	<0.500	<0.500	<0.500	918
Benzo(a)pyrene	<0.500	<0.500	<0.500	<0.500	<0.500	9.18
Indeno(1.2.3.cd)pyrene	<0.500	<0.500	<0.500	<0.500	<0.500	91.8
Dibenz(a.h)anthracene	<0.500	<0.500	<0.500	<0.500	<0.500	9.18
Benzo(g.h.i)perylene	<0.500	<0.500	<0.500	<0.500	<0.500	10,000

5 Final Inspection and Record Checking Findings

5.1 General

According to Section 3.2.5 of the SCAP, it is recommended that final inspection and record checking should be conducted right before decommissioning/ demolition of the concerned above-ground fuel tank and the above-ground emergency generator for respective Emergency Power Supply Systems to ensure no contaminative activities during the period from the time of preparation of SCAP till the decommissioning. Summary of final inspection and record checking are given in ensuing paragraphs. Photo records of final inspections are presented in **Appendix J**.

5.1.1 Final Inspection and Record Checking Findings

5.1.1.1 Emergency Power Supply System No.2

Final Inspection

The above-ground fuel tank (i.e. BH9) and emergency generator (i.e. HS1) of EPSS2 were disconnected in late-May 2020. As advised by the contractor, the fuel inside EPSS2 was removed in late-June 2020. Hence the final inspection of the BH9 and HS1 was conducted on 8 July 2020. During our final inspection, BH9 and HS1 were at the same locations as for the time of preparation of SCAP in 2018. Both facilities were mounted on intact concrete floor with no oil stain observed, and no oil stain was observed inside the drip tray of the above-ground fuel tank (BH9). In addition, bund wall was provided in the access of the fuel tank room.

The fuel pipelines running through BH9 and HS1 were buried by sand inside a concrete and brick trench at floor level. Two sections of the pipelines were checked by removing the chequer plate cover and no sign of leakage was observed. Photo records of final inspections are presented in **Appendix J1** and **Appendix J2**.

Record Checking

Available monthly maintenance records of the BH9 and HS1 from the time of SCAP preparation (i.e. March 2018) to February 2020 (month of last maintenance) were checked. No abnormality on fuel re-filling record was observed and no fuel tank leakage was recorded. It is concluded that there was no fuel leakage for the above-ground facilities BH9 and HS1 from the time of SCAP preparation till decommissioning/ demolition.

5.1.1.2 Emergency Power Supply System No.3

Final Inspection

The above-ground fuel tank (i.e. BH7) and emergency generator (i.e. BH8) of EPSS3 were decommissioned in early-April 2020. Final inspection of the BH7 and BH8 was conducted on 1 April 2020. During our final inspection, BH7 and BH8 were at the same locations as for the time of preparation of SCAP in 2018. The above-ground fuel tank (BH7) was surrounded by concrete curb and no oil stain was observed inside its drip tray, and the emergency generator (BH8) was mounted on intact concrete floor with no oil stain observed.

The fuel pipelines running through BH7 and BH8 were buried by sand inside a concrete and brick trench at floor level. Two sections of the pipelines were checked by removing the chequer plate cover and no sign of leakage was observed. Photo records of final inspections are presented in **Appendix J3** and **Appendix J4**.

Record Checking

Available monthly maintenance records of the BH7 and BH8 from the time of SCAP preparation (i.e. March 2018) to March 2020 (month of last maintenance) were checked. No abnormality on fuel re-filling record was observed and no fuel tank leakage was recorded. It is concluded that there was no fuel leakage for the above-ground facilities BH7 and BH8 from the time of SCAP preparation till decommissioning/ demolition.

5.1.1.3 Emergency Power Supply System No.5

Final Inspection

The above-ground fuel tank (i.e. HS4) and emergency generator (i.e. HS5) of EPSS5 were decommissioned in late-May 2020. Final inspection of the HS4 and HS5 was conducted on 25 May 2020. During our final inspection, HS4 and HS5 were at the same locations as for the time of preparation of SCAP in 2018. Both facilities are mounted on intact concrete floor with no oil stain observed, and no oil stain was observed inside the drip tray of the above-ground fuel tank (HS4). In addition, curb wall was provided in the access of the fuel tank room.

The fuel pipelines running through HS4 and HS5 were buried by sand inside a concrete and brick trench at floor level. Two sections of the pipelines were checked by removing the chequer plate cover and no sign of leakage was observed. Photo records of final inspections are presented in **Appendix J5**.

Record Checking

Available monthly maintenance records of the HS4 and HS5 from the time of SCAP preparation (i.e. March 2018) to February 2020 (month of last maintenance) were checked. No abnormality on fuel re-filling record was observed and no fuel tank leakage was recorded. It is concluded that there was no fuel leakage for the above-ground facilities HS4 and HS5 from the time of SCAP preparation till decommissioning/ demolition.

6 Conclusion

Enhanced SI programme have been conducted for the underground sections, BH5 and BH6, during June to August 2020. During the enhanced SI programme, a total of 3 sand samples and 6 soil samples were collected and testing of CoCs was undertaken. The testing results indicated that all the samples at BH5 and BH6 were below the RBRGs standard for industrial. Based on the sample testing results, it is considered that there are no land contamination issues at the BH6, including the segment running through BH6-S2 and BH6-S3 as per the site photo record taken at BH6-S2 and BH6-S3. To sum up, it is considered that there are no land contamination issues at BH5 and BH6, therefore remediation works are not required.

To err on a conservative side, additional site photo records at the sides and bottom of BH6-S2 and BH6-S3 will be submitted to EPD upon the demolition at these two specific sampling points to reaffirm the conclusion drawn in **Section 3.1.2** that there was no diesel leakage from the underground fuel pipes. In case that sign of diesel leakage is spotted during the demolition works, agreement from EPD shall be sought for sampling strategy and subsequent SI shall be arranged in accordance with the agreed sampling plan. A CAR should be submitted for the subsequent SI work and if remediation is required, a Remediation Action Plan and Remediation Report will also be prepared for submission to EPD.

Final inspection and record checking were conducted right before decommissioning/ demolition of the above-ground section of EPSS2 (i.e. BH9 and HS1), EPSS3 (i.e. BH7 and BH8) and EPSS5 (i.e. HS4 and HS5). According to the inspection and record checking results, it is concluded that there was no contaminative activities during the period from the preparation of SCAP till decommissioning/demolition of the above-ground facilities.

Appendices

A.	Updated Implementation Schedule of Land Contamination – Construction Phase	24
B.	Location of Emergency Power Supply Systems of T2 Building	25
C.	Identified Potential Land Contaminated Source of Emergency Power Supply Systems in SCAP	26
D.	Indicative Sampling Point Selection of 3,000 L Underground Fuel Tank of EPSS3 in SCAP (i.e. BH5)	27
E.	Indicative Sampling Point of the Underground Pipeline Trench of EPSS3 in SCAP (ie.BH6)	28
F.	Structure and Actual Sampling Depth of 3,000 L Underground Fuel Tank of EPSS3 (i.e. BH5)	29
G.	Actual Sampling Point of the Underground Pipeline Trench of EPSS3 (i.e. BH6-S1, BH6-S4, BH6-S5, BH6-S6, BH6-NLTS1)	30
H.	Chain-of-Custody Record	31
I.	Laboratory Testing Results of BH5 and BH6	32
J.	Site Photo Record of Final Inspection	33

A. Updated Implementation Schedule of Land Contamination – Construction Phase

Updated Appendix C Table 1 of EM&A Manual: Implementation Schedule

EIA Ref.	EM&A Ref.	EP Condition	Environmental Protection Measures	Location / Duration of measures Timing of completion of measures	Mitigation Measures Implemented?*
Land Contamination – Construction Phase					
11.10.1.2 to 11.10.1.3	8.1	2.32	<p>For areas inaccessible during site reconnaissance survey</p> <ul style="list-style-type: none"> Further site reconnaissance would be conducted once the areas are accessible in order to identify any land contamination concern for the areas. 	<p>Fuel Tank Room to the West of CAD Antenna Farm⁽¹⁾ / May 2017</p> <hr/> <p>Fuel Tank Room within T2 Building⁽¹⁾ / May 2017, Jan and Feb 2018</p> <hr/> <p>Seawater Pump House⁽¹⁾ / Sep 2016</p> <hr/> <p>Switching Station⁽¹⁾ / Sep 2016</p> <hr/> <p>Pumping Station⁽¹⁾ / Dec 2016</p> <hr/> <p>Fire Training Facility⁽¹⁾ / May 2017</p> <hr/> <p>Fuel Tank Room to the West of CAD Antenna Farm⁽²⁾⁽³⁾ / Aug 2018</p> <hr/> <p>Fuel Tank Room within T2 Building⁽²⁾⁽³⁾ / Aug 2018</p> <hr/> <p>Fire Training Facility⁽²⁾⁽³⁾ / Aug 2018</p> <hr/> <p>Airside Petrol Filling Station⁽³⁾ / Aug 2018</p>	<p>I</p> <hr/> <p>I</p> <hr/> <p>I (no contaminative land use types were identified and no further site investigation was required.)</p> <hr/> <p>I (relocation of switching station was not required. No site appraisal process for land contamination potential was required)</p> <hr/> <p>I (no contaminative land use types were identified and no further site investigation was required.)</p> <hr/> <p>I</p> <hr/> <p>I (Supplementary CAP was approved in August 2018)</p> <hr/> <p>I</p> <hr/> <p>I</p>
			<ul style="list-style-type: none"> Subject to further site reconnaissance findings, a supplementary Contamination Assessment Plan (CAP) for additional site investigation (SI) (if necessary) may be prepared and submitted to EPD for endorsement prior to the commencement of SI at these areas. 		

EIA Ref.	EM&A Ref.	EP Condition	Environmental Protection Measures	Location / Duration of measures Timing of completion of measures	Mitigation Measures Implemented?*
			<ul style="list-style-type: none"> After completion of SI, the Contamination Assessment Report (CAR) will be prepared and submitted to EPD for approval prior to start of the proposed construction works at the golf course, the underground and above-ground fuel storage tank areas, emergency power generation units, airside petrol filling station and fuel tank room. 	Fuel Tank Room to the West of CAD Antenna Farm ⁽³⁾ / No development programme for this area at this stage	N/A
				Fuel Tank Rooms within T2 Building ⁽³⁾	I (CAR for T2 EPSS No.1 Volumes 1 and 2 was approved on 2 March 2020 and 7 May 2020) (CAR for T2 EPSS Nos.2,.3 and 5 has been submitted to EPD) (CAR for T2 EPSS No.4 is under preparation)
				Fire Training Facility ⁽³⁾ / No development programme for this area at this stage	N/A
				Airside Petrol Filling Station ⁽³⁾ / No development programme for this area at this stage	N/A
				SkyCity Golf Course ⁽⁴⁾	I (CAR for golf course was approved on 6 April 2016)
			<ul style="list-style-type: none"> Should remediation be required, Remediation Action Plan (RAP) and Remediation Report (RR) will be prepared for EPD's approval prior to commencement of the proposed remediation and any construction works respectively. 	Project Site Area where remediation is required	N/A (No remediation is required so far)
11.8.1.2	8.1	-	If contaminated soil is identified, the following mitigation measures are for the excavation and transportation of contaminated materials (if any): <ul style="list-style-type: none"> To minimize the incidents of construction workers coming in contact with any contaminated materials, bulk earth-moving excavation equipment should be employed; Contact with contaminated materials can be minimised by wearing appropriate clothing and personal protective equipment such as gloves and masks (especially when working directly with contaminated material), provision of washing facilities and prohibition of smoking and eating on site; Stockpiling of contaminated excavated materials on site should be avoided as far as possible; The use of any contaminated soil for landscaping purpose should be avoided unless pre-treatment was carried out; 	Project Site Area where contaminated soil is identified	N/A (No contaminated soil has been found so far)

EIA Ref.	EM&A Ref.	EP Condition	Environmental Protection Measures	Location / Duration of measures Timing of completion of measures	Mitigation Measures Implemented?*
			<ul style="list-style-type: none"> ▪ Vehicles containing any excavated materials should be suitably covered to reduce dust emissions and/or release of contaminated wastewater; ▪ Truck bodies and tailgates should be sealed to prevent any discharge; ▪ Only licensed waste haulers should be used to collect and transport contaminated material to treatment/disposal site and should be equipped with tracking system to avoid fly tipping; ▪ Speed control for trucks carrying contaminated materials should be exercised. 8km/h is the recommended speed limit; ▪ Strictly observe all relevant regulations in relation to waste handling, such as Waste Disposal Ordinance (Cap 354), Waste Disposal (Chemical Waste) (General) Regulation (Cap 354) and obtain all necessary permits where required; and ▪ Maintain records of waste generation and disposal quantities and disposal arrangements. 		

***Notes:**

I= implemented where applicable;

N/A= not applicable

Remarks:

- (1) Project Site Area inaccessible during site reconnaissance in EIA stage according to Section 1.10.1.2. of the EIA Report.
- (2) Project Site Area where the need for Further Site Investigation was evaluated as stipulated in Table 3.2 of the Supplementary Contamination Assessment Plan (SCAP) approved in August 2018.
- (3) Project Site Area where Site Investigation was recommended in Table 3.4 of the SCAP approved in August 2018.
- (4) Project Site Area where Site Investigation to be carried out by Airport Management Services according to Section 11.6.1 of the EIA Report.

B. Location of Emergency Power Supply Systems of T2 Building

B.1 Location of Emergency Power Supply Systems of T2 Building (Overview)

B.2 Location of Emergency Power Supply System No.2 of T2 Building (Zoom-in View of Northern Section of T2 Building)

B.3 Location of Emergency Power Supply System No.3, Emergency Power Supply System No.4 and Emergency Power Supply System No.5 of T2 Building (Zoom-in View of Southern Section of T2 Building)

Appendix B.1 Location of Emergency Power Supply Systems of T2 Building (Overview)

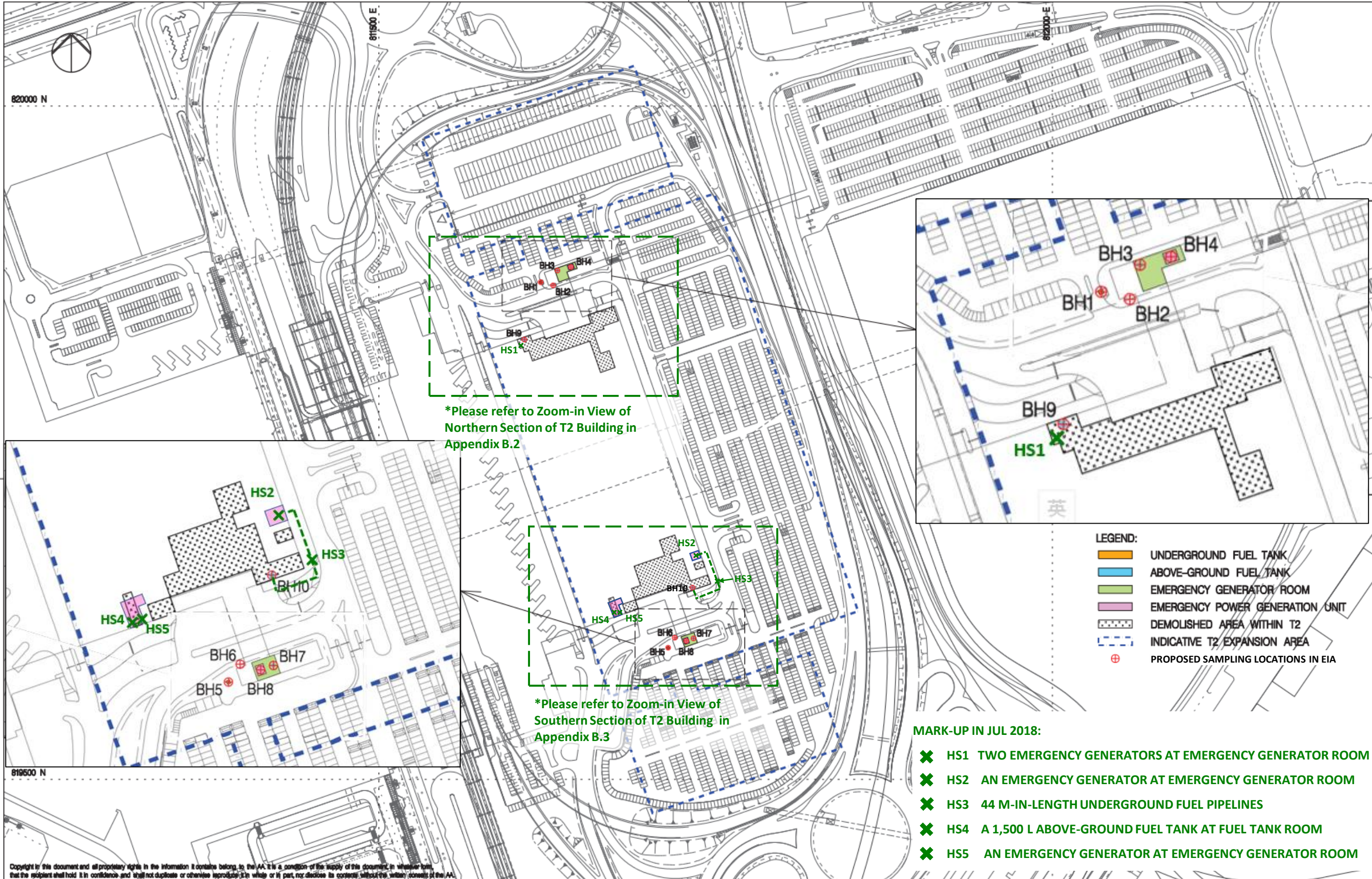

*Please refer to Zoom-in View of Northern Section of T2 Building in Appendix B.2

*Please refer to Zoom-in View of Southern Section of T2 Building in Appendix B.3

- LEGEND:**
- UNDERGROUND FUEL TANK
 - ABOVE-GROUND FUEL TANK
 - EMERGENCY GENERATOR ROOM
 - EMERGENCY POWER GENERATION UNIT
 - DEMOLISHED AREA WITHIN T2
 - INDICATIVE T2 EXPANSION AREA
 - ⊗ PROPOSED SAMPLING LOCATIONS IN EIA

- MARK-UP IN JUL 2018:**
- ⊗ HS1 TWO EMERGENCY GENERATORS AT EMERGENCY GENERATOR ROOM
 - ⊗ HS2 AN EMERGENCY GENERATOR AT EMERGENCY GENERATOR ROOM
 - ⊗ HS3 44 M-IN-LENGTH UNDERGROUND FUEL PIPELINES
 - ⊗ HS4 A 1,500 L ABOVE-GROUND FUEL TANK AT FUEL TANK ROOM
 - ⊗ HS5 AN EMERGENCY GENERATOR AT EMERGENCY GENERATOR ROOM

Copyright in this document and all proprietary rights in the information it contains belong to the AA. It is a condition of the supply of this document, in whatever form, that the recipient shall hold it in confidence and shall not disclose or otherwise reproduce it in whole or in part, nor disclose its contents, without the written consent of the AA.

Rev.	Date	Description	Checked
A	23OCT13	FIRST ISSUE	EC
B	21NOV13	GENERAL REVISION	AM
C	17DEC13	GENERAL REVISION	AM



PROPOSED SAMPLING LOCATIONS FOR EXPANSION OF T2 BUILDING

Consultant's Signatures for Approval		Date
Design	AM	23OCT13
Checkers	AM	23OCT13
Design Supervisor	EC	21MAR14
Authorised Representative	AFK	21MAR14

EXPANSION OF HONG KONG INTERNATIONAL AIRPORT INTO A THREE-RUNWAY SYSTEM		Scale at A3
Drawing No.	MCL / P132 / EIA / 11-014	1 : 2500
Rev.	C	

Appendix B.2 Location of Emergency Power Supply System No.2 (EPSS2) of T2 Building (Zoom-in View of Northern Section of T2 Building)

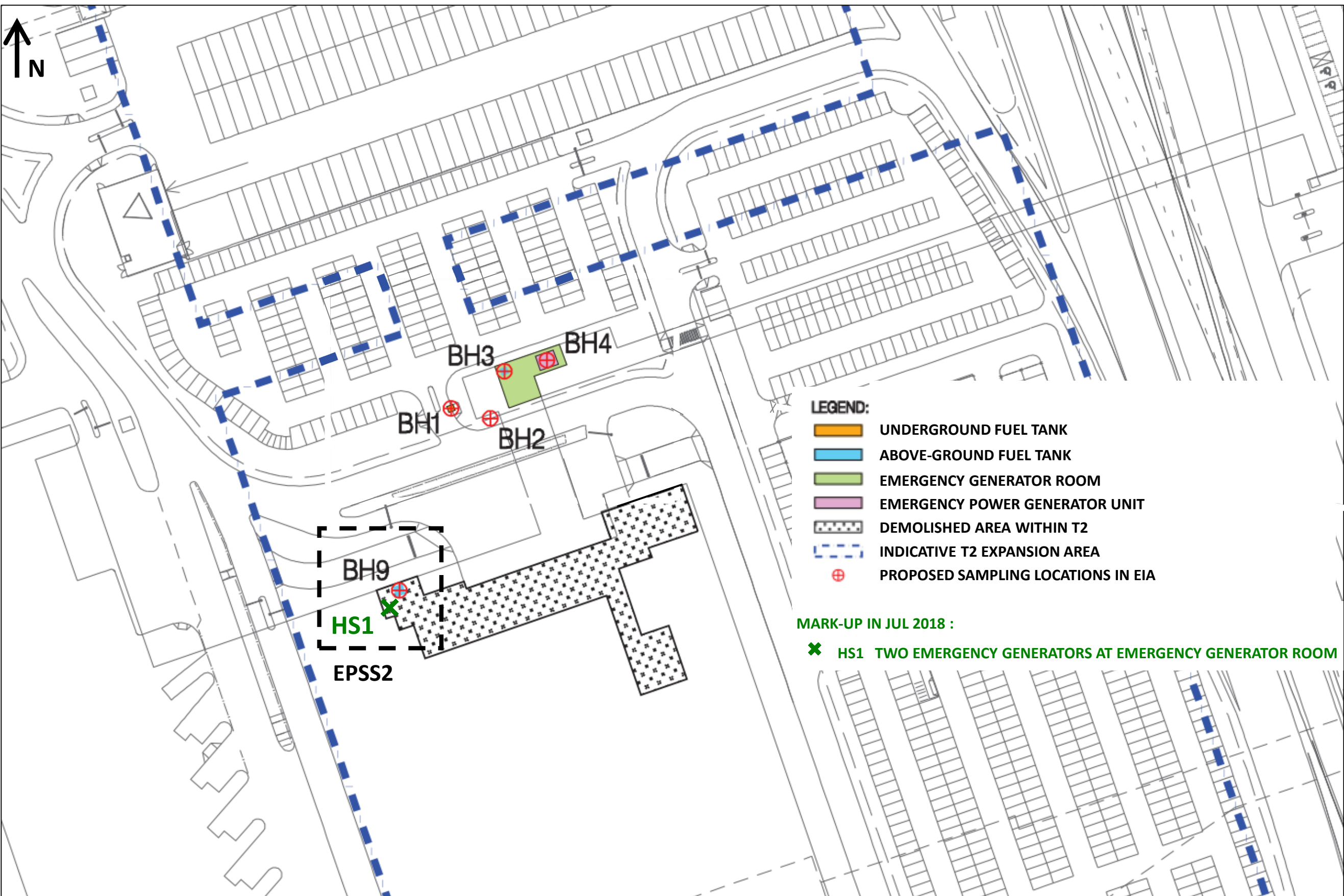

Appendix B.3 Location of Emergency Power Supply System No.3 (EPSS3) and Emergency Power Supply System No.5(EPSS5) of T2 Building (Zoom-in View of Southern Section of T2 Building)

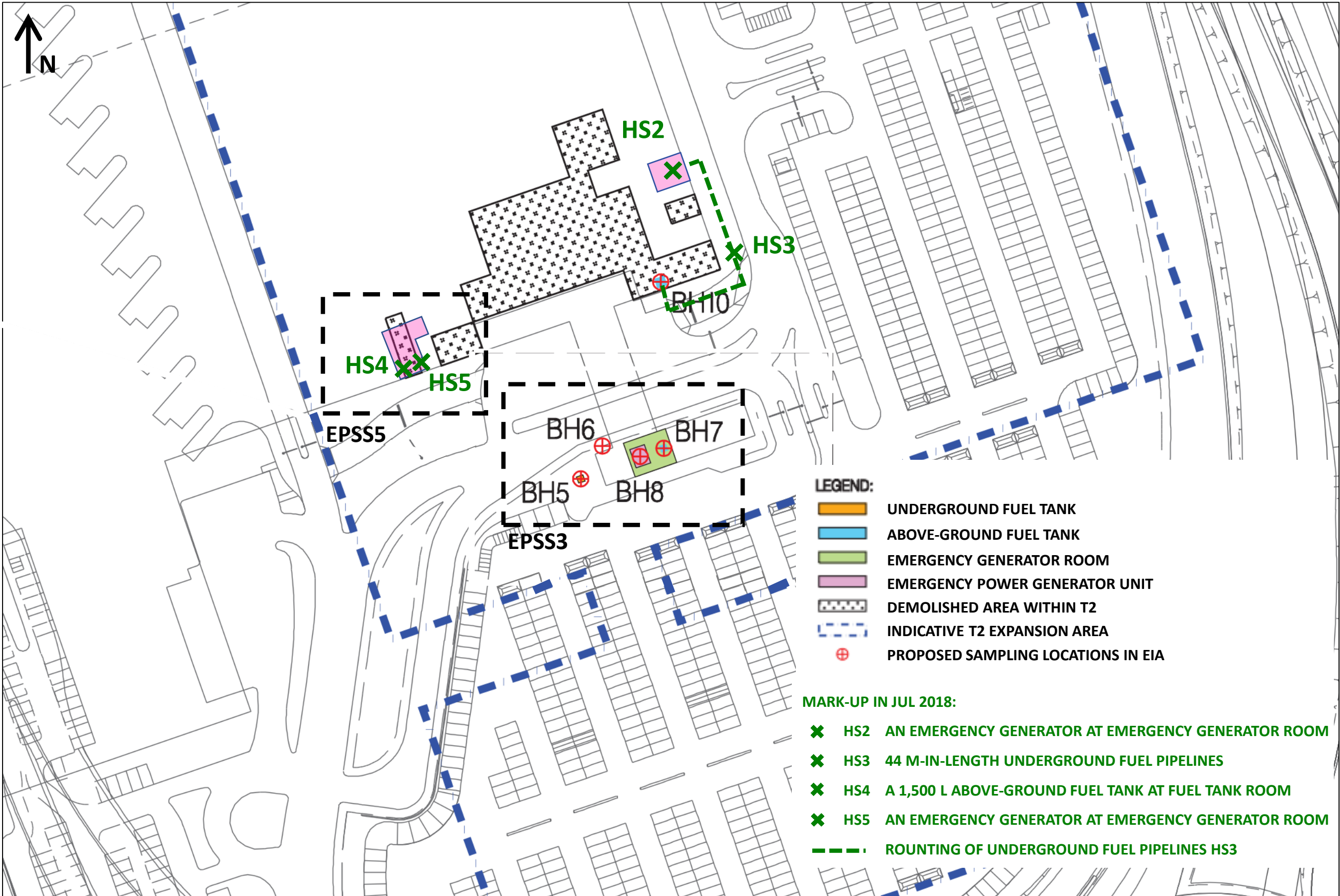

C. Identified Potential Land Contaminated Source of Emergency Power Supply Systems in SCAP

- C.1 Identified Potential Land Contaminated Source of Emergency Power Supply System No.2 (EPSS2) in SCAP**
- C.2 Identified Potential Land Contaminated Source of Emergency Power Supply System No.3 (EPSS3) in SCAP**
- C.3 Identified Potential Land Contaminated Source of Emergency Power Supply System No.5 (EPSS5) in SCAP**

Appendix C.1 Identified Potential Land Contaminated Source of Emergency Power Supply System No.2 (EPSS2) in SCAP

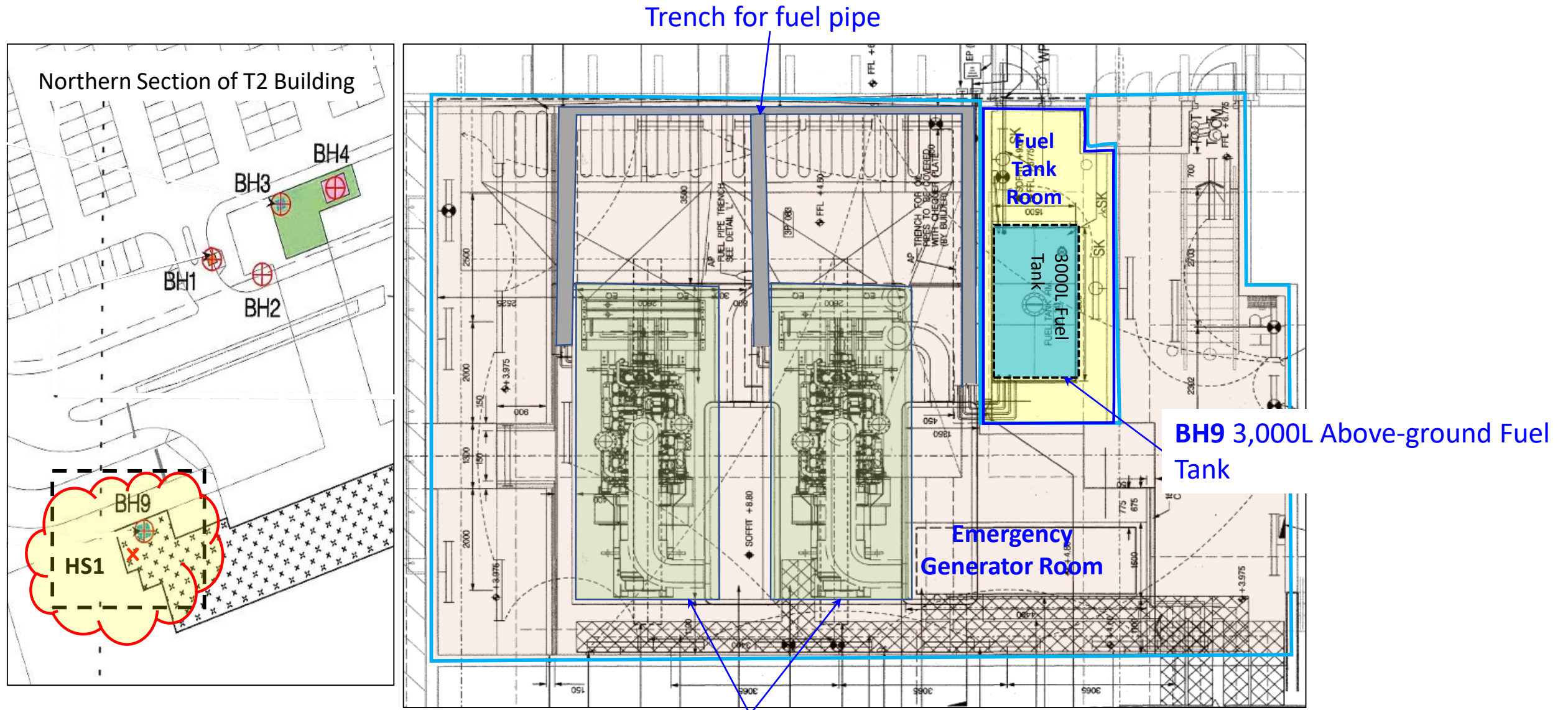

HS1 Emergency Generators
(Stand on **200mm-thick concrete plinth**)

Reference ID	Description
BH9	A 3,000 L above-ground fuel tank at Fuel Tank Room
HS1	Two above-ground emergency generators at Emergency Generator Room, connected to 3,000 L above-ground fuel tank (i.e. BH9)

Appendix C.2 Identified Potential Land Contaminated Source of Emergency Power Supply System No.3 (EPSS3) in SCAP

Southern Section of T2 Building

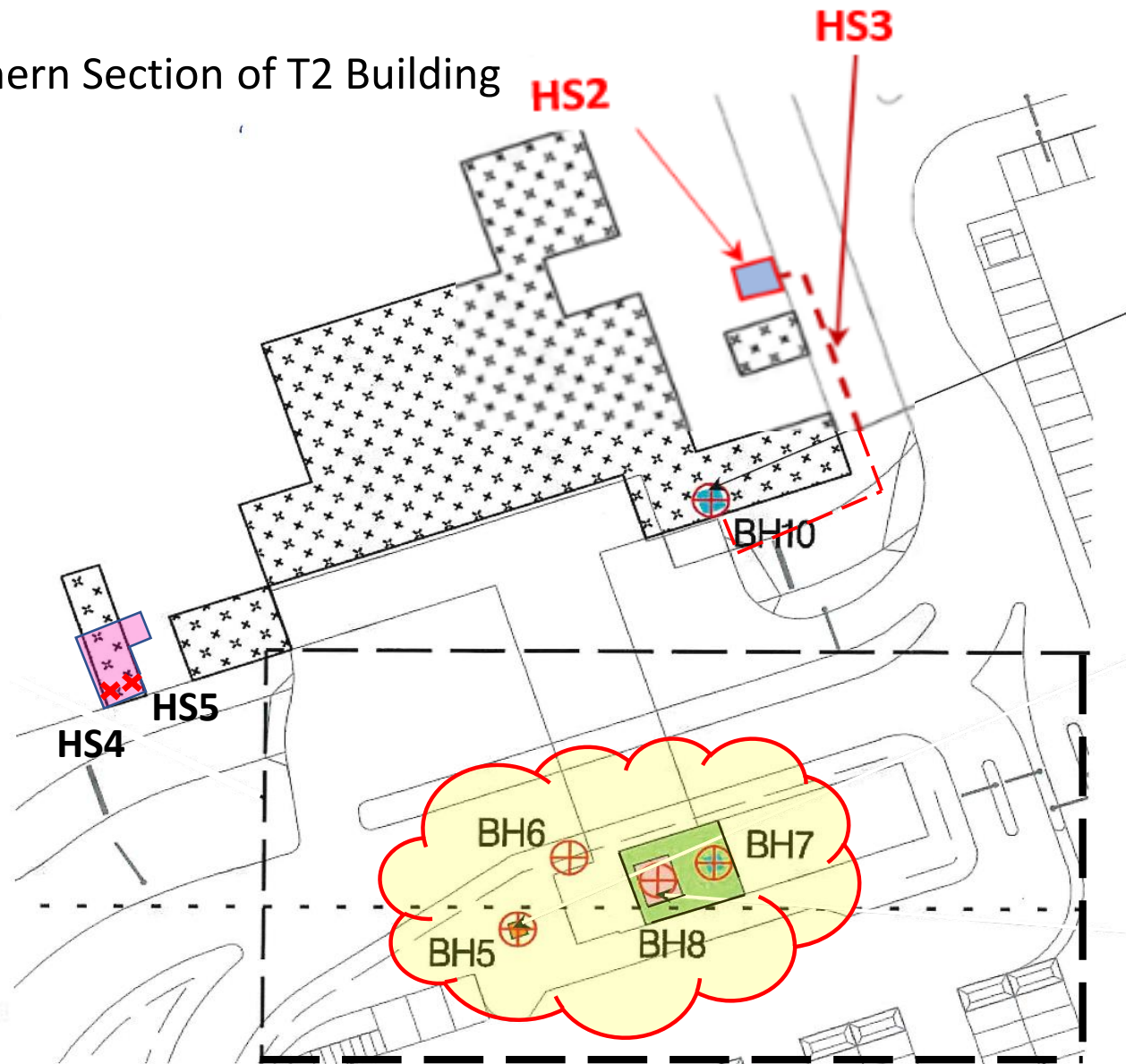

**BH5 3,000L
Underground Fuel tank**

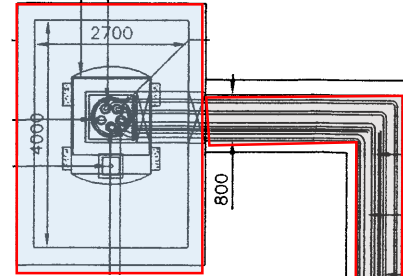

**BH8 Emergency
Generator**

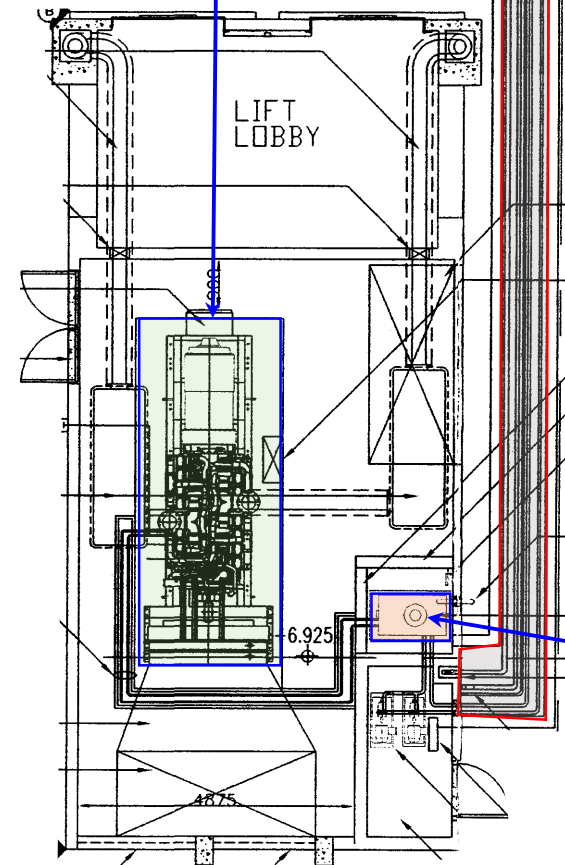

**BH6 Underground Fuel
Pipelines
Total Length: Approx. 26 m**

**BH7 450L Above-
ground Fuel Tank**

Reference ID	Description
BH5	A 3,000 L underground fuel tank
BH7	A 450 L above-ground fuel tank at Emergency Generator Room
BH6	26 m-in-length underground fuel pipelines connecting the 3,000 L underground fuel tank (i.e. BH5) and the 450 L above-ground fuel tank (i.e. BH7)
BH8	An emergency generator at Emergency Generator Room (above-ground)

Appendix C.3 Identified Potential Land Contaminated Source of Emergency Power Supply System No.5 (EPSS5) in SCAP

Reference ID	Description
HS4	A 1,500 L above-ground fuel tank at Fuel Tank Room
HS5	An emergency generator at Emergency Generator Room (above-ground)

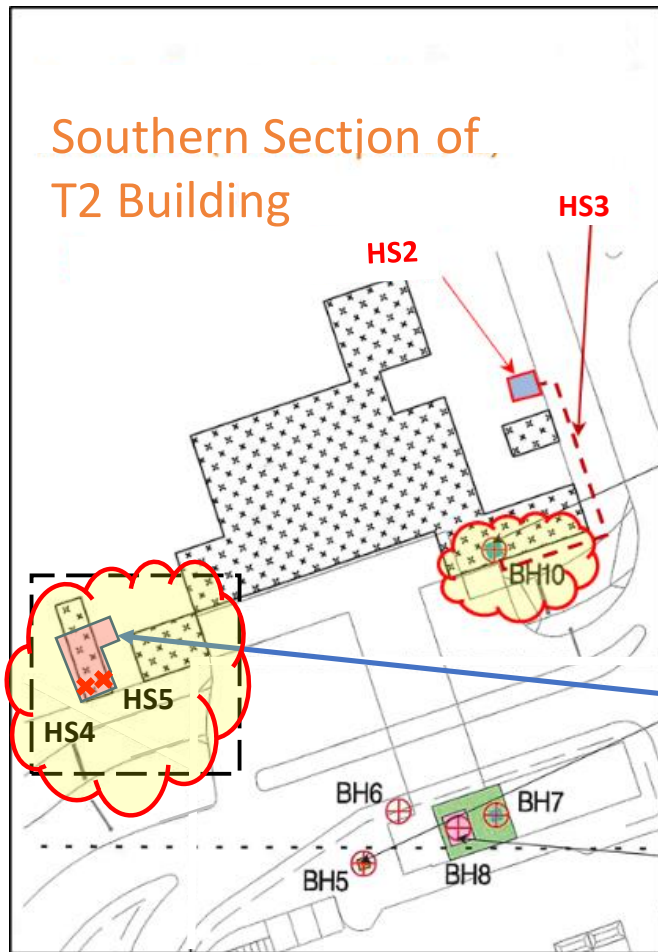

HS4
1,500L Above-ground Fuel Tank

HS5 Emergency Generator (Mounted on 200mm-thick concrete plinth)

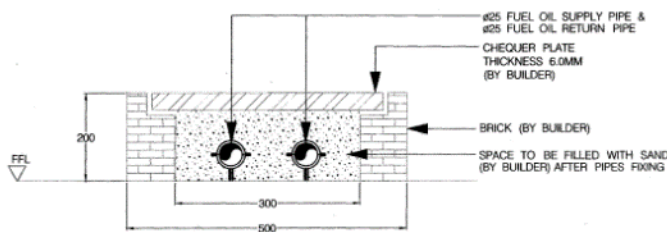
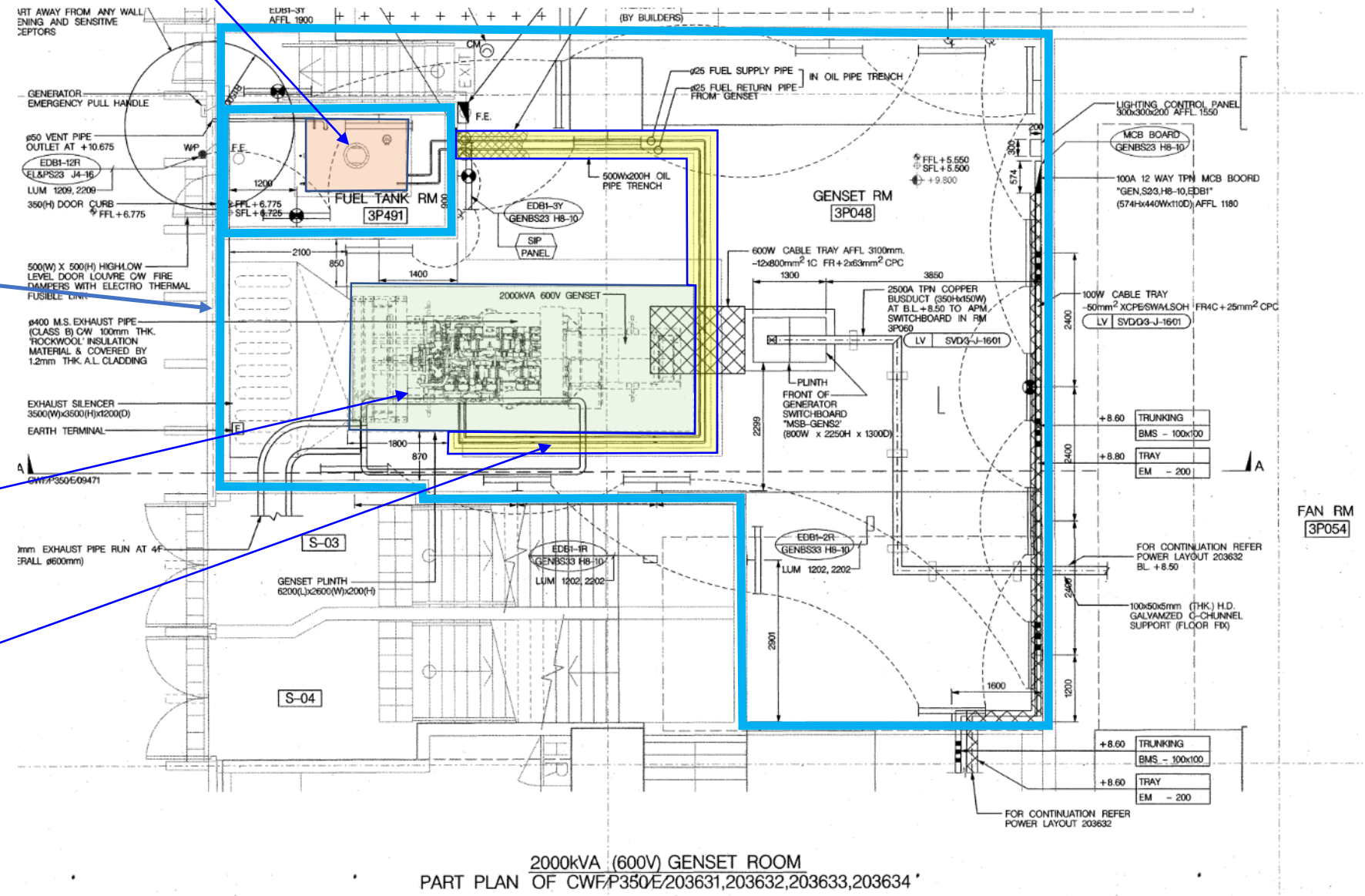



Supply and return pipe from fuel oil tank (Sand Filled Trench at floor level)

D. Indicative Sampling Point Selection of 3,000 L Underground Fuel Tank of EPSS3 in SCAP (i.e. BH5)

Appendix D Indicative Sampling Point Selection of 3,000 L Underground Fuel Tank of EPSS3 in SCAP (i.e. BH5)

Type of Sample	Sampling Point Selection Strategy
Sand	0.5 m, 1.5 m Below Ground Surface and bottom level inside the concrete chamber
Soil	Right underneath concrete chamber

- Legend:**
-  Sand Sampling Point
 -  Soil Sampling Point

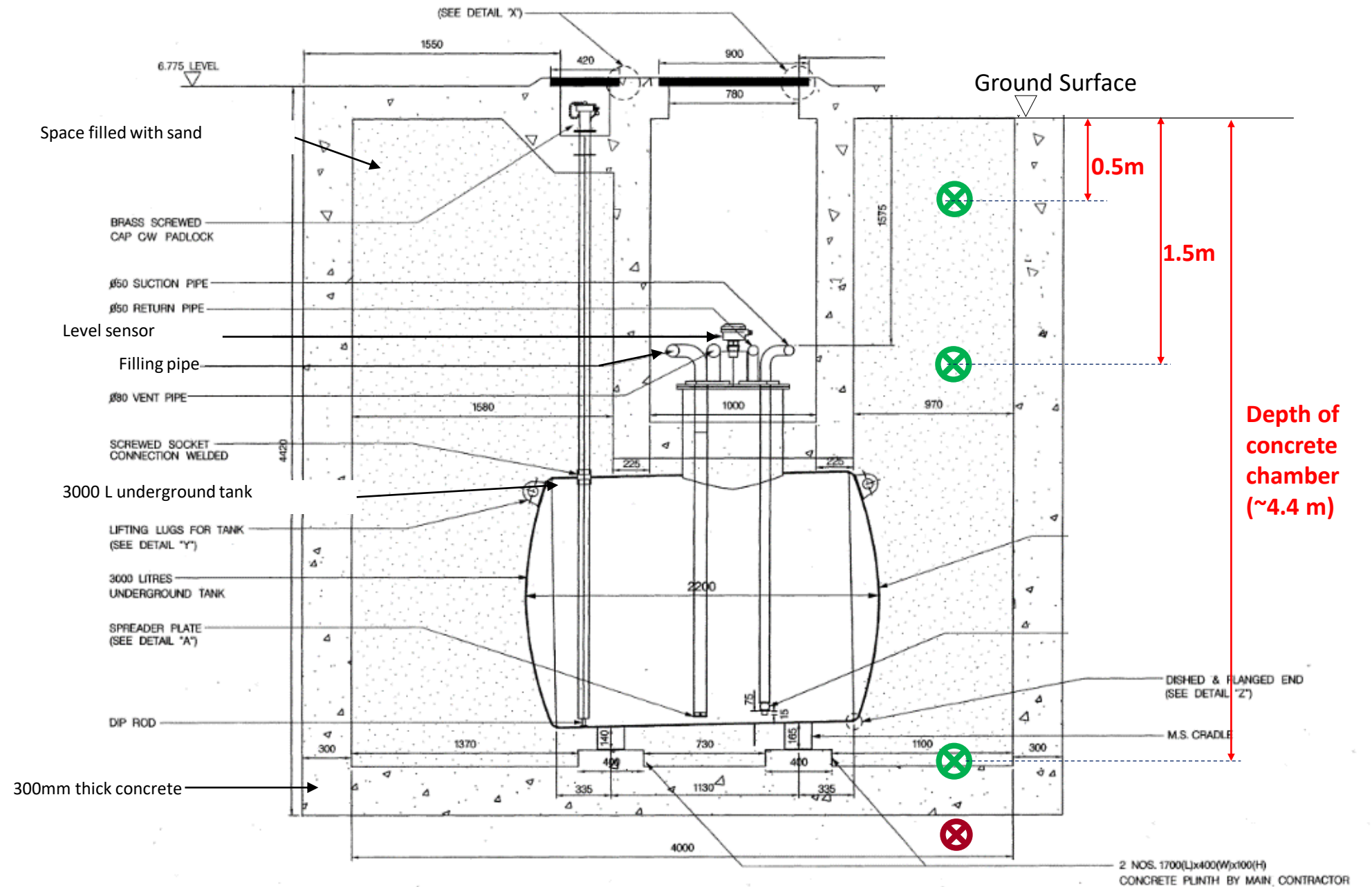



Indicative Sampling Point Selection of 3,000 L Underground Fuel Tank of Emergency Power Supply System No.3 (i.e. BH5)

E. Indicative Sampling Point of the Underground Pipeline Trench of EPSS3 in SCAP (ie.BH6)

Appendix E Indicative Sampling Point of the Underground Pipeline Trench of EPSS3 in SCAP (ie. BH6)

Annotation of Sampling Point	Type of Sampling Point (Curvature/ Additional)	Type of Sample	
		At the level of fuel pipelines (Within Concrete Trench)	Right underneath concrete trench
BH6-S1	Curvature	Sand	Soil
BH6-S2	Additional		-
BH6-S3	Additional		-
BH6-S4	Curvature		Soil

LEGEND:

-  Curvature Sampling Point
-  Additional Sampling Point

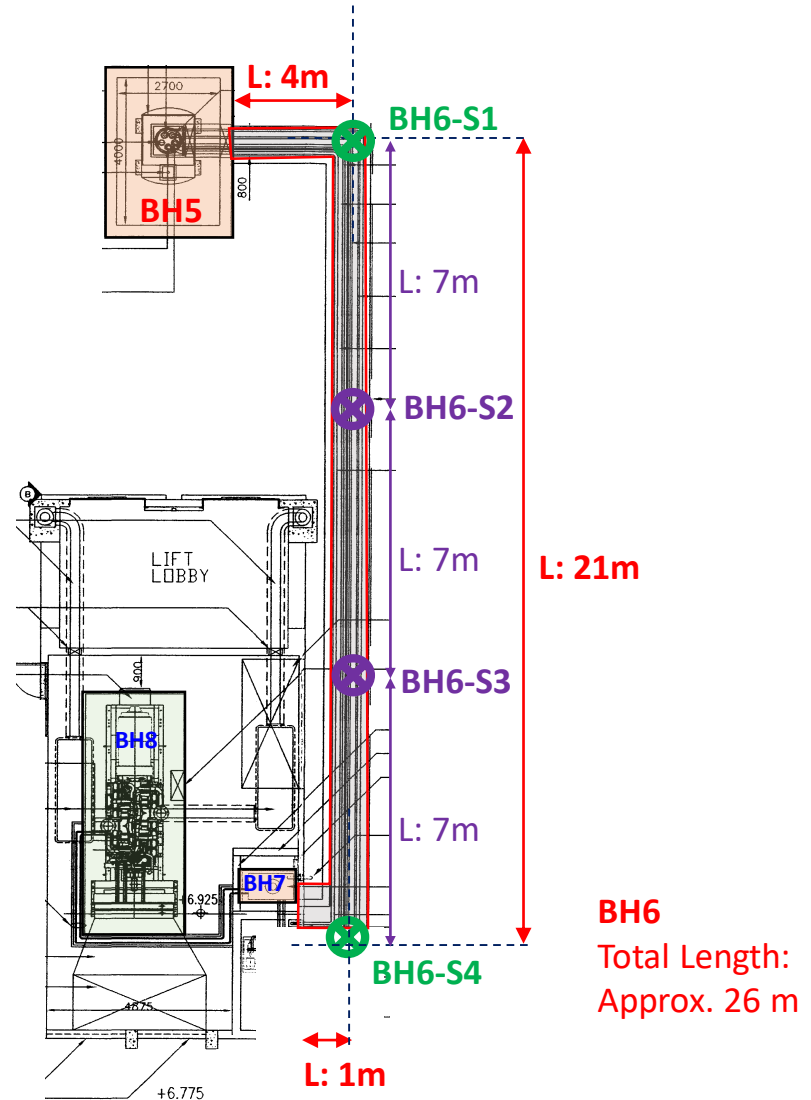

Indicative Sampling Point Selection of Underground Pipeline Trench of Emergency Power Supply System No.3 (i.e. BH6)

F. Structure and Actual Sampling Depth of 3,000 L Underground Fuel Tank of EPSS3 (i.e. BH5)

Appendix F Structure and Actual Sampling Depth of 3,000 L Underground Fuel Tank of EPSS3 (i.e. BH5)

<u>Sample</u>	<u>Sampling Point Selection Strategy</u>
Sand	0.5 m, 1.5 m below top concrete slab, 1.0m below second concrete slab
Soil	0.5m below base concrete slab

Legend:
 Actual Sampling Point

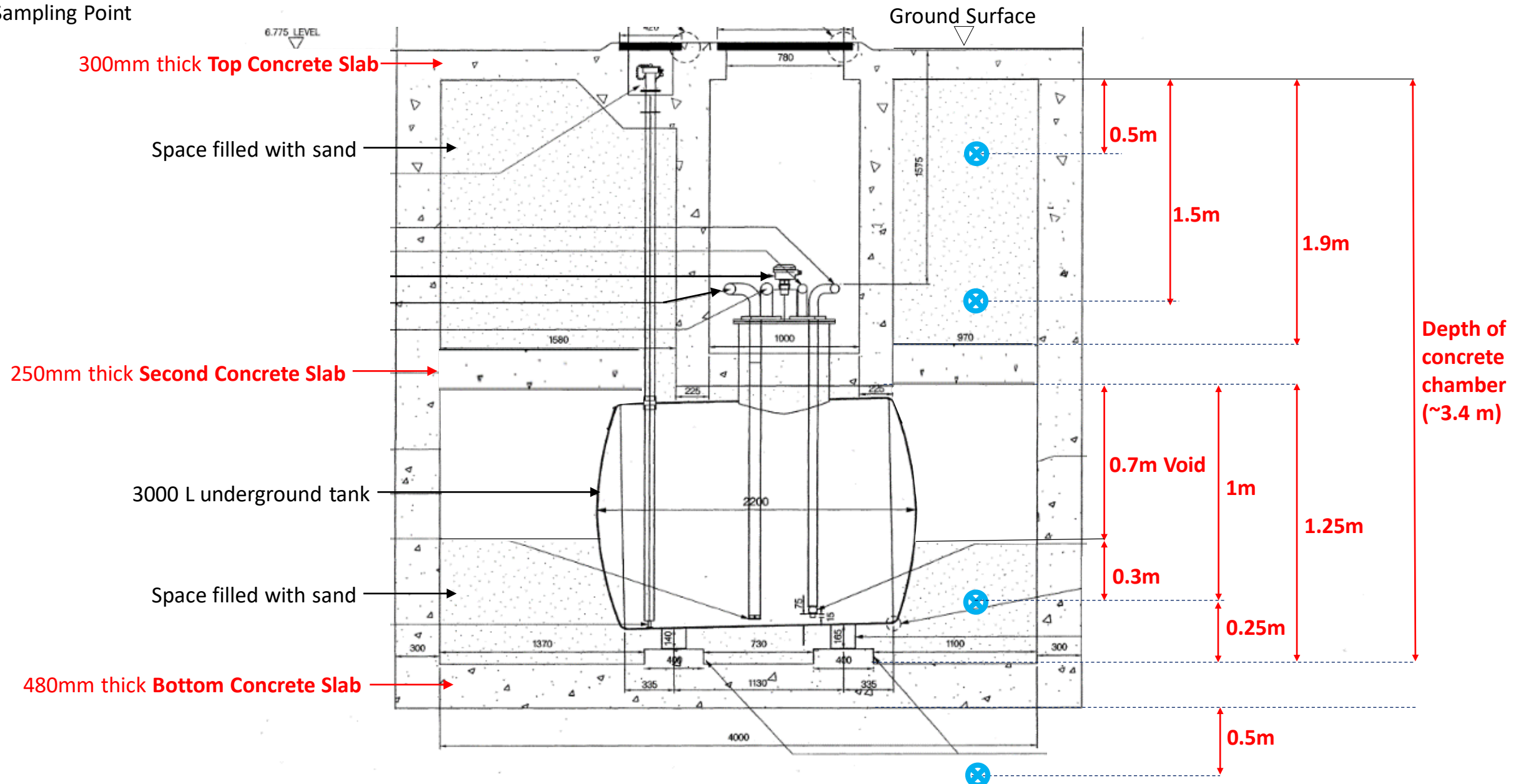

Actual Sampling Point Selection of 3,000 L Underground Fuel Tank of Emergency Power Supply System No.3 (i.e. BH5)

G. Actual Sampling Point of the Underground Pipeline Trench of EPSS3 (i.e. BH6-S1, BH6-S4, BH6-S5, BH6-S6, BH6-NLTS1)

- G.1 Actual Sampling Point of the Underground Pipeline Trench of EPSS3 (i.e. BH6-S1, BH6-S4, BH6-S5, BH6-S6, BH6-NLTS1)**
- G.2 Site Photo Record of Underground Pipeline Trench of EPSS3 at BH6-S2 and BH6-S3 (Photo Record)**

Appendix G.1 Actual Sampling Point of the Underground Pipeline Trench of EPSS3 (i.e. **BH6-S1, BH6-S4, BH6-S5, BH6-S6, BH6-NLTS1**)

<i>Annotation of Sampling Point</i>	<i>Type of Sampling Point</i>	<i>Sampling Elevation</i>	<i>Type of Sample</i>	<i>Remarks</i>
BH6-S1	Curvature	Right underneath concrete trench corner	Soil	Same sampling point selection in SCAP
BH6-S4	Curvature			
BH6-S5	Curvature (Newly added according to on-site condition)			Newly added according to on-site condition (Curvature of pipeline)
BH6-S6	Curvature (Newly added according to on-site condition)			Newly added according to on-site condition (Segment of underground pipeline not laid in concrete trench)
BH6-NLTS1	Newly added according to on-site condition	Right underneath the segment of underground pipeline		Newly added according to on-site condition (Segment of underground pipeline not laid in concrete trench)

LEGEND:

⊗ Sampling Point proposed in SCAP with photo record taken on 24 Jul 2020

⊕ Actual Sampling Point

TEXT On-site Measurement of Underground Pipeline/ Concrete Trench

▨ Segment of underground pipeline not laid in concrete trench

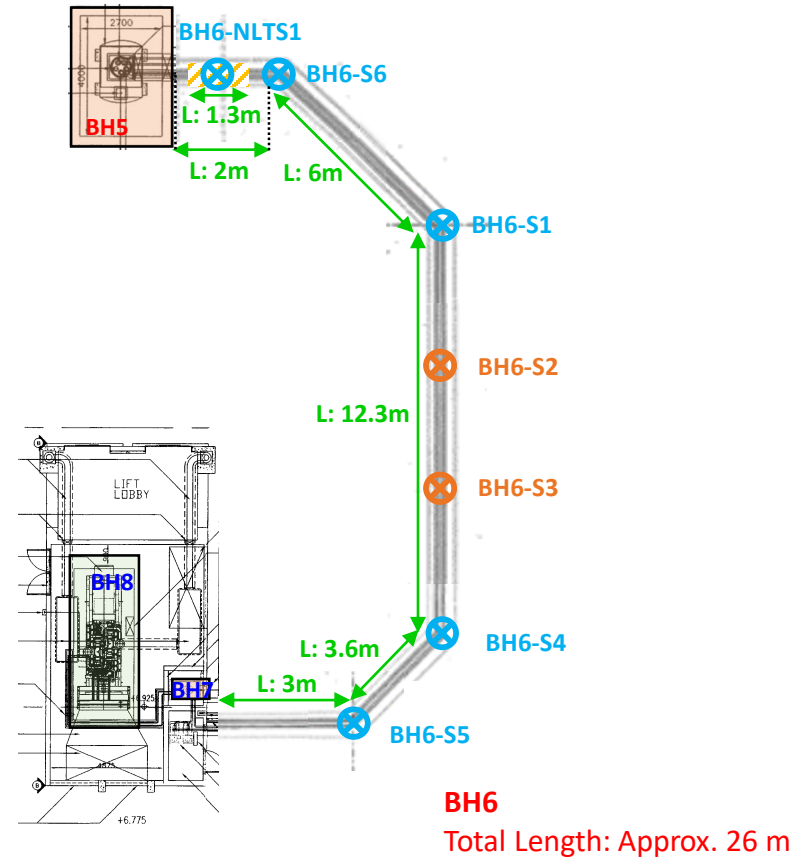

Actual Sampling Point of Underground Pipeline Trench of Emergency Power Supply System No.3 (i.e. **BH6**)

Appendix G.2 Site Photo Record of Underground Pipeline Trench of EPSS3 at **BH6-S2** and **BH6-S3** (Photo Record)



BH6-S2 and BH6-S3 View 1

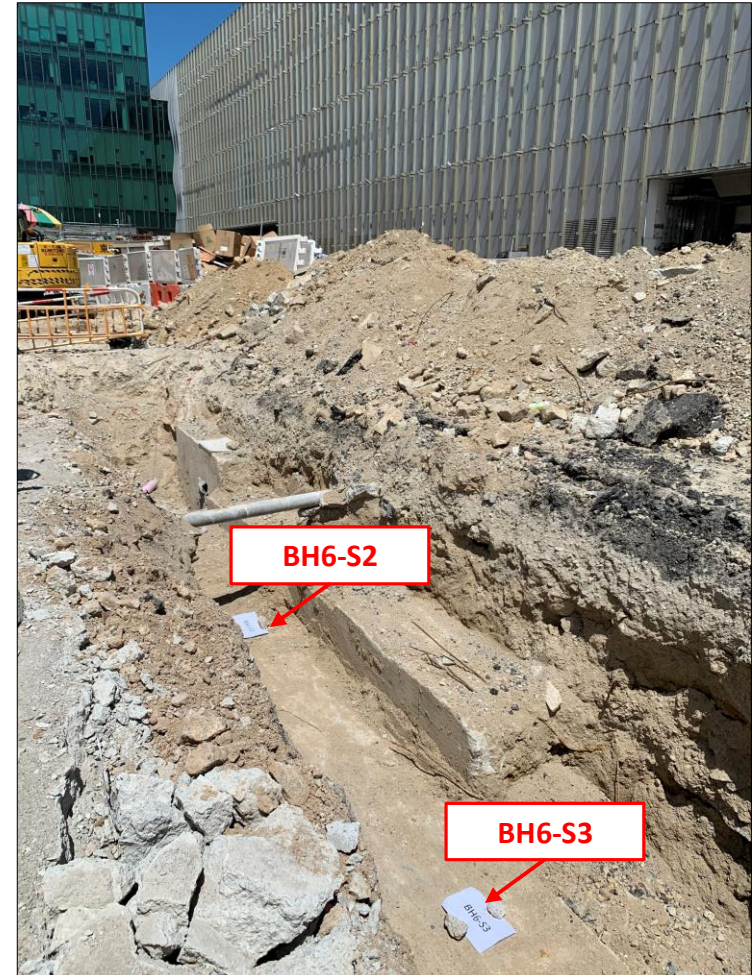

BH6-S2 and BH6-S3 View 2

H. Chain-of-Custody Record

CHAIN OF CUSTODY DOCUMENTATION

H 030963



ALS Laboratory Group

CLIENT: Mott MacDonald HK Limited
 ADDRESS / OFFICE: Mott MacDonald, 3/F International Trade Tower, 348 Kowloon Road, Kowloon, HK
 PROJECT MANAGER (PM): Thomas Chan
 PROJECT ID: Soil Testing at Hong Kong Airport
 SITE: Contract No. 3503 TD Foundation & SW P.O. NO.:

SAMPLER:
 MOBILE: 9307 9680 (Liz Lo)
 PHONE: 2828 5751 (Liz Lo)
 EMAIL REPORT TO:
 EMAIL INVOICE TO: (if different to report)

RESULTS REQUIRED (Date): QUOTE NO.: HKE11861c/2018

ANALYSIS REQUIRED including SUITES (note - suite codes must be listed to attract suite prices)

FOR LABORATORY USE ONLY
 COOLER SEAL (circle appropriate)
 Intact: Yes No N/A
 SAMPLE TEMPERATURE
 CHILLED: Yes No

COMMENTS / SPECIAL HANDLING / STORAGE OR DISPOSAL:

✓	✓	✓	✓	✓	✓															
---	---	---	---	---	---	--	--	--	--	--	--	--	--	--	--	--	--	--	--	--

Notes: e.g. Highly contaminated samples
 e.g. "High PAHs expected"
 Extra volume for QC or trace LORs etc.

SAMPLE INFORMATION (note: S = Soil, W=Water) CONTAINER INFORMATION

ALS ID	SAMPLE ID	MATRIX	DATE	Time	Type / Code	Total bottles
1.	Trip Blank	W	29/6/2020		Vials	2
2.	Equipment Blank	W	29/6/2020		1x Amber, 2x Vials, 1x plastic	
3.	Field Blank	W	29/6/2020		1x Amber, 2x Vials, 1x plastic	
4.	BH5-500MMBTS	S	29/6/2020		Glass Jar	1
5.	BH5-500MMBTS (Duplicate)	S	29/6/2020		Glass Jar	1
6.	BH5-1500MMBTS	S	29/6/2020		Glass Jar	1

Lead	TPH	BETX	MTBE	PAH	C6-C8
		✓	✓		✓
✓	✓	✓	✓	✓	
✓	✓	✓	✓	✓	
✓	✓	✓	✓	✓	
✓	✓	✓	✓	✓	

RELINQUISHED BY:
 Name: Thomas Chan Date: 29 June 2020
 Of: Mott MacDonald Time:

RECEIVED BY:
 Name: [Signature] Date: 29/6/20
 Of: ALS (HK) Time: 16:55

METHOD OF SHIPMENT
 Con' Note No:
 Transport Co:

Water Container Codes: P = Unpreserved Plastic; N = Nitric Preserved Plastic; ORC = Nitric Preserved ORC; SH = Sodium Hydroxide/Cd Preserved; S = Sodium Hydroxide Preserved Plastic; AG = Amber Glass Unpreserved;
 V = VOA Vial HCl Preserved; VS = VOA Vial Sulphuric Preserved; SG = Sulphuric Preserved Amber Glass; H = HCl Preserved Plastic; HS = HCl Preserved Speciation Bottle; SP = Sulphuric Preserved Plastic; F = Formaldehyde Preserved Glass;
 Z = Zinc Acetate Preserved Bottle; E = EDTA Preserved Bottle; ST = Sterile Bottle; ASS = Plastic Bag for Acid Sulphate Soil; B = Unpreserved Bag.

CHAIN OF CUSTODY DOCUMENTATION

H 030965



ALS Laboratory Group

CLIENT: Mott MacDonald HK Limited
 ADDRESS / OFFICE: Mott MacDonald, 3/F International Trade Tower, 378 Queen's Road
 PROJECT MANAGER (PM): Thomas Chan
 PROJECT ID: SOT1 Testing at Hong Kong Airport
 SITE: Contract No. 3503 T2 Fuel Oil & SW P.O. NO.:

SAMPLER:
 MOBILE: 9307 9680 (Liz Lo)
 PHONE: 2828 5751 (Liz Lo)
 EMAIL REPORT TO: ~~liz.lo@mottmac.com~~ liz.lo@mottmac.com
 EMAIL INVOICE TO: (if different to report)

RESULTS REQUIRED (Date): QUOTE NO.: HKE/18612/2018

ANALYSIS REQUIRED including SUITES (note - suite codes must be listed to attract suite prices)

FOR LABORATORY USE ONLY
 COMMENTS / SPECIAL HANDLING / STORAGE OR DISPOSAL:
 COOLER SEAL (circle appropriate)
 Intact: Yes No N/A
 SAMPLE TEMPERATURE
 CHILLED: Yes No

Notes: e.g. Highly contaminated samples
 e.g. "High PAHs expected"
 Extra volume for QC or trace LORs etc.

SAMPLE INFORMATION (note: S = Soil, W=Water) CONTAINER INFORMATION

ALS ID	SAMPLE ID	MATRIX	DATE	Time	Type / Code	Total bottles	Lead	TAM	BETX	MTBE	PAH	Colif									
1	Trip Blank	W	24/7/20		Vials	2			✓	✓		✓									
2	BH6 - NUTS1	S	24/7/20		Glass Jar	1	✓	✓	✓	✓	✓										
3	BH6 - S1	S	24/7/20		Glass Jar	1	✓	✓	✓	✓	✓										
4	BH6 - S4	S	24/7/20		Glass Jar	1	✓	✓	✓	✓	✓										
5	BH6 - S5	S	24/7/20		Glass Jar	1	✓	✓	✓	✓	✓										
6	BH6 - S6	S	24/7/20		Glass Jar	1	✓	✓	✓	✓	✓										

RELINQUISHED BY:
 Name: Thomas Chan Date: 24/7/2020
 Of: Mott MacDonald HK Limited
 Name: Date:
 Of: Time:

RECEIVED BY:
 Name: ALS (HK) Date: 24/7/20
 Of: Time: 15:16

METHOD OF SHIPMENT
 Con' Note No:
 Transport Co:

Water Container Codes: P = Unpreserved Plastic; N = Nitric Preserved Plastic; ORC = Nitric Preserved ORC; SH = Sodium Hydroxide/Cd Preserved; S = Sodium Hydroxide Preserved Plastic; AG = Amber Glass Unpreserved;
 V = VOA Vial HCl Preserved; VS = VOA Vial Sulphuric Preserved; SG = Sulphuric Preserved Amber Glass; H = HCl Preserved Plastic; HS = HCl Preserved Speciation Bottle; SP = Sulphuric Preserved Plastic; F = Formaldehyde Preserved Glass;
 Z = Zinc Acetate Preserved Bottle; E = EDTA Preserved Bottle; ST = Sterile Bottle; ASS = Plastic Bag for Acid Sulphate Soil; B = Unpreserved Bag.

CHAIN OF CUSTODY DOCUMENTATION

H 030966



ALS Laboratory Group

CLIENT: Mott MacDonald HK Limited
 ADDRESS / OFFICE: Mott MacDonald, 3/F International Trade Tower, 348 Kowloon Road East, Kowloon, HK
 PROJECT MANAGER (PM): Thomas Chan

SAMPLER: Liz Lo
 MOBILE: 9307 9680 (Liz Lo)
 PHONE: 2828 5751 (Liz Lo)

PROJECT ID: Soil Testing at Hong Kong Airport
 SITE: Contract No. 3503 T2 Foundation & SW P.O. NO.:

EMAIL REPORT TO:
 EMAIL INVOICE TO: (if different to report)

RESULTS REQUIRED (Date): QUOTE NO.: HKE118610/2018

ANALYSIS REQUIRED including SUITES (note - suite codes must be listed to attract suite prices)

FOR LABORATORY USE ONLY
 COOLER SEAL (circle appropriate)
 Intact: Yes No (N/A)
 SAMPLE TEMPERATURE
 CHILLED: (Yes) No

COMMENTS / SPECIAL HANDLING / STORAGE OR DISPOSAL:

Notes: e.g. Highly contaminated samples
 e.g. "High PAHs expected"
 Extra volume for QC or trace LORs etc.

SAMPLE INFORMATION (note: S = Soil, W=Water) CONTAINER INFORMATION

ALS ID	SAMPLE ID	MATRIX	DATE	Time	Type / Code	Total bottles	Lead	TPH	BEIX	MTBE	PAH	C6-CR											
1.	Trip Blank	W	20/8/2020		Viols	2			✓	✓		✓											
2.	BH5-1000 B2NDS	S	20/8/2020		Glass Jar	1	✓	✓	✓	✓	✓												
3.	BH5-UNDERS 500	S	20/8/2020		Glass Jar	1	✓	✓	✓	✓	✓												
	BH5	S	20/8/2020		Glass Jar	1	✓	✓	✓	✓	✓												

RELINQUISHED BY:
 Name: Thomas Chan Date: 20 Aug 2020
 Of: Mott MacDonald
 Name: Date:
 Of: Time:

RECEIVED BY:
 Name: Sau Na Date: 20 Aug 2020
 Of: ALS (HK) Time: 17:15
 Name: Date:
 Of: Time:

METHOD OF SHIPMENT
 Con' Note No:
 Transport Co:

Water Container Codes: P = Unpreserved Plastic; N = Nitric Preserved Plastic; ORC = Nitric Preserved ORC; SH = Sodium Hydroxide/Cd Preserved; S = Sodium Hydroxide Preserved Plastic; AG = Amber Glass Unpreserved;
 V = VOA Vial HCl Preserved; VS = VOA Vial Sulphuric Preserved; SG = Sulfuric Preserved Amber Glass; H = HCl Preserved Plastic; HS = HCl Preserved Speciation Bottle; SP = Sulfuric Preserved Plastic; F = Formaldehyde Preserved Glass;
 Z = Zinc Acetate Preserved Bottle; E = EDTA Preserved Bottle; ST = Sterile Bottle; ASS = Plastic Bag for Acid Sulphate Soil; B = Unpreserved Bag.

I. Laboratory Testing Results of BH5 and BH6





CERTIFICATE OF ANALYSIS

Client	: MOTT MACDONALD HONG KONG LIMITED	Laboratory	: ALS Technichem (HK) Pty Ltd	Page	: 1 of 13
Contact	: THOMAS CHAN	Contact	: Richard Fung	Work Order	: HK2024008
Address	: 3/F INTERNATIONAL TRADE TOWER, 348 KWUN TONG ROAD, KWUN TONG, KOWLOON, HONG KONG	Address	: 11/F., Chung Shun Knitting Centre, 1 - 3 Wing Yip Street, Kwai Chung, N.T., Hong Kong		
E-mail	: thomas.chan@mottmac.com	E-mail	: richard.fung@alsglobal.com		
Telephone	: +852 2828 5933	Telephone	: +852 2610 1044	Date Samples Received	: 29-Jun-2020
Facsimile	: +852 2828 1823	Facsimile	: +852 2610 2021	Issue Date	: 09-Jul-2020
Project	: SOIL TESTING AT HONG KONG AIRPORT			No. of samples received	: 6
Order number	: ---	Quote	: HKE/1861c/2018_V2	No. of samples analysed	: 6
		number			
C-O-C number	: H030963				
Site	: CONTRACT NO. C3503 TERMINAL 2 FOUNDATION AND SUBSTRUCTURE WORKS				

This report may not be reproduced except with prior written approval from the testing laboratory.

Hong Kong Accreditation Service (HKAS) has accredited this laboratory, ALS Technichem (HK) Pty Ltd (Reg. No. HOKLAS 066) under Hong Kong Laboratory Accreditation Scheme (HOKLAS) for specific laboratory activities as listed in the HOKLAS Directory of Accredited Laboratories.

This document has been signed by those names that appear on this report and are the authorised signatories.

Signatories	Position	Authorised results for
 Anh Ngoc Huynh .	Senior Chemist	Organics_ENV
 Chan Siu Ming , Vico	Manager - Inorganics	Inorganics
 Leung Chak Cheong , Mike	Senior Chemist	Metals_ENV



General Comments

This report supersedes any previous report(s) with this reference. All pages of this report have been checked and approved for release. When sampling time information is not provided by the client, sampling dates are shown without a time component. In these instances, the time component has been assumed by the laboratory for processing purposes. Testing period is from 29-Jun-2020 to 08-Jul-2020.

Key: LOR = Limit of reporting; CAS Number = CAS registry number from database maintained by Chemical Abstracts Services. The Chemical Abstracts Service is a division of the American Chemical Society.

Specific Comments for Work Order: HK2024008

Sample(s) was/ were submitted by client. Sample(s) arrived laboratory in chilled condition. The result(s) related only to the item(s) tested.

Sample information (Project name, Sample ID, Sampling date/time, etc., if any) is provided by client.

Result(s) of soil/sediment sample(s) was / were reported on dry weight basis.

Water sample(s) were filtered prior to dissolved metal analysis.

EP070 is the numeric code for internal use. Test method for C6-C9 Fraction of TPH is EP071.

Sample(s) as received, digested by In-house method E-ASTM D3974-09 prior to determination of metals. The In-house method is developed based on ASTM D3974-09 method.



Analytical Results

Sub-Matrix: SOIL

Client sample ID

				BH5-500MMBTS	BH5-500MMBTS (Duplicate)	BH5-1500MMBTS	---	---
				29-Jun-2020	29-Jun-2020	29-Jun-2020	----	----
Client sampling date / time				HK2024008-004	HK2024008-005	HK2024008-006	-----	-----
Compound	CAS Number	LOR	Unit					
EA/ED: Physical and Aggregate Properties								
EA055: Moisture Content (dried @ 103°C)	----	0.1	%	8.2	8.3	8.4	---	---
EG: Metals and Major Cations								
EG020: Lead	7439-92-1	1	mg/kg	8	8	7	---	---
EP-076HK: Polycyclic Aromatic Hydrocarbons (PAHs)								
EP076HK: Naphthalene	91-20-3	0.500	mg/kg	<0.500	<0.500	<0.500	---	---
EP076HK: Acenaphthylene	208-96-8	0.500	mg/kg	<0.500	<0.500	<0.500	---	---
EP076HK: Acenaphthene	83-32-9	0.500	mg/kg	<0.500	<0.500	<0.500	---	---
EP076HK: Fluorene	86-73-7	0.500	mg/kg	<0.500	<0.500	<0.500	---	---
EP076HK: Phenanthrene	85-01-8	0.500	mg/kg	<0.500	<0.500	<0.500	---	---
EP076HK: Anthracene	120-12-7	0.500	mg/kg	<0.500	<0.500	<0.500	---	---
EP076HK: Fluoranthene	206-44-0	0.500	mg/kg	<0.500	<0.500	<0.500	---	---
EP076HK: Pyrene	129-00-0	0.500	mg/kg	<0.500	<0.500	<0.500	---	---
EP076HK: Benz(a)anthracene	56-55-3	0.500	mg/kg	<0.500	<0.500	<0.500	---	---
EP076HK: Chrysene	218-01-9	0.500	mg/kg	<0.500	<0.500	<0.500	---	---
EP076HK: Benzo(b)fluoranthene	205-99-2	0.500	mg/kg	<0.500	<0.500	<0.500	---	---
EP076HK: Benzo(k)fluoranthene	207-08-9	0.500	mg/kg	<0.500	<0.500	<0.500	---	---
EP076HK: Benzo(a)pyrene	50-32-8	0.500	mg/kg	<0.500	<0.500	<0.500	---	---
EP076HK: Indeno(1.2.3.cd)pyrene	193-39-5	0.500	mg/kg	<0.500	<0.500	<0.500	---	---
EP076HK: Dibenz(a.h)anthracene	53-70-3	0.500	mg/kg	<0.500	<0.500	<0.500	---	---
EP076HK: Benzo(g,h,i)perylene	191-24-2	0.500	mg/kg	<0.500	<0.500	<0.500	---	---
EP-071HK_SR: Total Petroleum Hydrocarbons (TPH)								
EP070HK_SR: C6 - C8 Fraction	----	5	mg/kg	<5	<5	<5	---	---
EP071HK_SR: C9 - C16 Fraction	----	200	mg/kg	<200	<200	<200	---	---
EP071HK_SR: C17 - C35 Fraction	----	500	mg/kg	<500	<500	<500	---	---
EP-074_SR-A: Monocyclic Aromatic Hydrocarbons (MAH)								
EP074_SR: Benzene	71-43-2	0.2	mg/kg	<0.2	<0.2	<0.2	---	---
EP074_SR: Toluene	108-88-3	0.5	mg/kg	<0.5	<0.5	<0.5	---	---
EP074_SR: Ethylbenzene	100-41-4	0.5	mg/kg	<0.5	<0.5	<0.5	---	---



Sub-Matrix: SOIL				Client sample ID	BH5-500MMBTS	BH5-500MMBTS (Duplicate)	BH5-1500MMBTS	---	---
Client sampling date / time				29-Jun-2020	29-Jun-2020	29-Jun-2020	----	----	
Compound	CAS Number	LOR	Unit	HK2024008-004	HK2024008-005	HK2024008-006	-----	-----	
EP-074 SR-A: Monocyclic Aromatic Hydrocarbons (MAH) - Continued									
EP074_SR: meta- & para-Xylene	108-38-3	1.0	mg/kg	<1.0	<1.0	<1.0	---	---	
	106-42-3								
EP074_SR: ortho-Xylene	95-47-6	0.5	mg/kg	<0.5	<0.5	<0.5	---	---	
EP074_SR: Xylenes (Total)	----	2.0	mg/kg	<2.0	<2.0	<2.0	---	---	
EP-074_SR-I: Methyl-tert-butyl Ether									
EP074_SR: Methyl tert-Butyl Ether (MTBE)	1634-04-4	0.2	mg/kg	<0.2	<0.2	<0.2	---	---	
EP-076S: Polycyclic Aromatics Hydrocarbons (PAHs) Surrogates									
EP076HK: 2-Fluorobiphenyl	321-60-8	0.1	%	102	97.5	103	---	---	
EP076HK: 4-Terphenyl-d14	1718-51-0	0.1	%	104	98.2	104	---	---	
EP-080_SRS: TPH(Volatile)/BTEX Surrogate									
EP070HK_SR: Dibromofluoromethane	1868-53-7	0.1	%	96.0	99.7	101	---	---	
EP070HK_SR: Toluene-D8	2037-26-5	0.1	%	102	103	104	---	---	
EP070HK_SR: 4-Bromofluorobenzene	460-00-4	0.1	%	104	105	105	---	---	
EP-074_SR-S: VOC Surrogates									
EP074_SR: Dibromofluoromethane	1868-53-7	0.1	%	96.0	99.7	101	---	---	
EP074_SR: Toluene-D8	2037-26-5	0.1	%	102	103	104	---	---	
EP074_SR: 4-Bromofluorobenzene	460-00-4	0.1	%	104	105	105	---	---	



Sub-Matrix: WATER				Client sample ID	Trip Blank	Equipment Blank	Field Blank	---	---
Client sampling date / time				29-Jun-2020	29-Jun-2020	29-Jun-2020	---	---	
Compound	CAS Number	LOR	Unit	HK2024008-001	HK2024008-002	HK2024008-003	---	---	
EG: Metals and Major Cations - Filtered									
EG020: Lead	7439-92-1	1	µg/L	---	<1	<1	---	---	
EP-076HK: Polycyclic Aromatic Hydrocarbons (PAHs)									
EP076HK: Naphthalene	91-20-3	2.0	µg/L	---	<2.0	<2.0	---	---	
EP076HK: Acenaphthylene	208-96-8	2.0	µg/L	---	<2.0	<2.0	---	---	
EP076HK: Acenaphthene	83-32-9	2.0	µg/L	---	<2.0	<2.0	---	---	
EP076HK: Fluorene	86-73-7	2.0	µg/L	---	<2.0	<2.0	---	---	
EP076HK: Phenanthrene	85-01-8	2.0	µg/L	---	<2.0	<2.0	---	---	
EP076HK: Anthracene	120-12-7	2.0	µg/L	---	<2.0	<2.0	---	---	
EP076HK: Fluoranthene	206-44-0	2.0	µg/L	---	<2.0	<2.0	---	---	
EP076HK: Pyrene	129-00-0	2.0	µg/L	---	<2.0	<2.0	---	---	
EP076HK: Benz(a)anthracene	56-55-3	2.0	µg/L	---	<2.0	<2.0	---	---	
EP076HK: Chrysene	218-01-9	1.0	µg/L	---	<1.0	<1.0	---	---	
EP076HK: Benzo(b)fluoranthene	205-99-2	1.0	µg/L	---	<1.0	<1.0	---	---	
EP076HK: Benzo(k)fluoranthene	207-08-9	2.0	µg/L	---	<2.0	<2.0	---	---	
EP076HK: Benzo(a)pyrene	50-32-8	2.0	µg/L	---	<2.0	<2.0	---	---	
EP076HK: Indeno(1,2,3.cd)pyrene	193-39-5	2.0	µg/L	---	<2.0	<2.0	---	---	
EP076HK: Dibenz(a,h)anthracene	53-70-3	2.0	µg/L	---	<2.0	<2.0	---	---	
EP076HK: Benzo(g,h,i)perylene	191-24-2	2.0	µg/L	---	<2.0	<2.0	---	---	
EP-071HK_SR: Total Petroleum Hydrocarbons (TPH)									
EP070HK_SR: C6 - C8 Fraction	----	20	µg/L	<20	<20	<20	---	---	
EP071HK_SR: C9 - C16 Fraction	----	500	µg/L	---	<500	<500	---	---	
EP071HK_SR: C17 - C35 Fraction	----	500	µg/L	---	2800	<500	---	---	
EP-074_SR-A: Monocyclic Aromatic Hydrocarbons (MAH)									
EP074_SR: Benzene	71-43-2	5.0	µg/L	<5.0	<5.0	<5.0	---	---	
EP074_SR: Toluene	108-88-3	5.0	µg/L	<5.0	<5.0	<5.0	---	---	
EP074_SR: Ethylbenzene	100-41-4	5.0	µg/L	<5.0	<5.0	<5.0	---	---	
EP074_SR: meta- & para-Xylene	108-38-3 106-42-3	10	µg/L	<10	<10	<10	---	---	
EP074_SR: ortho-Xylene	95-47-6	5.0	µg/L	<5.0	<5.0	<5.0	---	---	
EP074_SR: Xylenes (Total)	----	20	µg/L	<20	<20	<20	---	---	



Sub-Matrix: WATER				Client sample ID	Trip Blank	Equipment Blank	Field Blank	---	---
				Client sampling date / time	29-Jun-2020	29-Jun-2020	29-Jun-2020	---	---
Compound	CAS Number	LOR	Unit	HK2024008-001	HK2024008-002	HK2024008-003	---	---	---
EP-074_SR-I: Methyl-tert-butyl Ether									
EP074_SR: Methyl tert-Butyl Ether (MTBE)	1634-04-4	0.5	µg/L	<0.5	<0.5	<0.5	---	---	---
EP-076S: Polycyclic Aromatics Hydrocarbons (PAHs) Surrogates									
EP076HK: 2-Fluorobiphenyl	321-60-8	0.1	%	---	52.0	57.0	---	---	---
EP076HK: 4-Terphenyl-d14	1718-51-0	0.1	%	---	91.4	108	---	---	---
EP-080_SRS: TPH(Volatile)/BTEX Surrogate									
EP070HK_SR: Dibromofluoromethane	1868-53-7	0.1	%	105	106	104	---	---	---
EP070HK_SR: Toluene-D8	2037-26-5	0.1	%	102	103	102	---	---	---
EP070HK_SR: 4-Bromofluorobenzene	460-00-4	0.1	%	104	104	103	---	---	---
EP-074_SR-S: VOC Surrogates									
EP074_SR: Dibromofluoromethane	1868-53-7	0.1	%	105	106	104	---	---	---
EP074_SR: Toluene-D8	2037-26-5	0.1	%	102	103	102	---	---	---
EP074_SR: 4-Bromofluorobenzene	460-00-4	0.1	%	104	104	103	---	---	---



Laboratory Duplicate (DUP) Report

Matrix: SOIL

Laboratory Duplicate (DUP) Report

Laboratory sample ID	Client sample ID	Method: Compound	CAS Number	LOR	Unit	Original Result	Duplicate Result	RPD (%)
EA/ED: Physical and Aggregate Properties (QC Lot: 3115104)								
HK2023994-001	Anonymous	EA055: Moisture Content (dried @ 103°C)	----	0.1	%	10.8	10.6	1.35
HK2024005-008	Anonymous	EA055: Moisture Content (dried @ 103°C)	----	0.1	%	9.1	9.1	0.00
EG: Metals and Major Cations (QC Lot: 3109627)								
HK2024008-005	BH5-500MMBTS (Duplicate)	EG020: Lead	7439-92-1	1	mg/kg	8	8	0.00
EP-076HK: Polycyclic Aromatic Hydrocarbons (PAHs) (QC Lot: 3107195)								
HK2023535-001	Anonymous	EP076HK: Naphthalene	91-20-3	50	µg/kg	<0.500 mg/kg	<500	0.00
		EP076HK: Acenaphthylene	208-96-8	50	µg/kg	<0.500 mg/kg	<500	0.00
		EP076HK: Acenaphthene	83-32-9	50	µg/kg	<0.500 mg/kg	<500	0.00
		EP076HK: Fluorene	86-73-7	50	µg/kg	<0.500 mg/kg	<500	0.00
		EP076HK: Phenanthrene	85-01-8	50	µg/kg	<0.500 mg/kg	<500	0.00
		EP076HK: Anthracene	120-12-7	50	µg/kg	<0.500 mg/kg	<500	0.00
		EP076HK: Fluoranthene	206-44-0	50	µg/kg	<0.500 mg/kg	<500	0.00
		EP076HK: Pyrene	129-00-0	50	µg/kg	<0.500 mg/kg	<500	0.00
		EP076HK: Benz(a)anthracene	56-55-3	50	µg/kg	<0.500 mg/kg	<500	0.00
		EP076HK: Chrysene	218-01-9	50	µg/kg	<0.500 mg/kg	<500	0.00
		EP076HK: Benzo(b)fluoranthene	205-99-2	50	µg/kg	<0.500 mg/kg	<500	0.00
		EP076HK: Benzo(k)fluoranthene	207-08-9	50	µg/kg	<0.500 mg/kg	<500	0.00
		EP076HK: Benzo(a)pyrene	50-32-8	50	µg/kg	<0.500 mg/kg	<500	0.00
		EP076HK: Indeno(1.2.3.cd)pyrene	193-39-5	50	µg/kg	<0.500 mg/kg	<500	0.00
EP076HK: Dibenz(a.h)anthracene	53-70-3	50	µg/kg	<0.500 mg/kg	<500	0.00		
EP076HK: Benzo(g.h.i)perylene	191-24-2	50	µg/kg	<0.500 mg/kg	<500	0.00		
EP-071HK_SR: Total Petroleum Hydrocarbons (TPH) (QC Lot: 3097063)								
HK2023240-001	Anonymous	EP071HK_SR: C9 - C16 Fraction	----	200	mg/kg	<200	<200	0.00
		EP071HK_SR: C17 - C35 Fraction	----	500	mg/kg	<500	<500	0.00
EP-071HK_SR: Total Petroleum Hydrocarbons (TPH) (QC Lot: 3097064)								
HK2023240-001	Anonymous	EP070HK_SR: C6 - C8 Fraction	----	5	mg/kg	<5	<5	0.00
EP-074_SR-A: Monocyclic Aromatic Hydrocarbons (MAH) (QC Lot: 3110256)								
HK2024063-007	Anonymous	EP074_SR: Benzene	71-43-2	0.1	mg/kg	<0.2	<0.2	0.00
		EP074_SR: Toluene	108-88-3	0.2	mg/kg	<0.5	<0.5	0.00
		EP074_SR: Ethylbenzene	100-41-4	0.2	mg/kg	<0.5	<0.5	0.00



Matrix: SOIL				Laboratory Duplicate (DUP) Report				
Laboratory sample ID	Client sample ID	Method: Compound	CAS Number	LOR	Unit	Original Result	Duplicate Result	RPD (%)
EP-074_SR-A: Monocyclic Aromatic Hydrocarbons (MAH) (QC Lot: 3110256) - Continued								
HK2024063-007	Anonymous	EP074_SR: ortho-Xylene	95-47-6	0.2	mg/kg	<0.5	<0.5	0.00
		EP074_SR: meta- & para-Xylene	108-38-3 106-42-3	0.4	mg/kg	<1.0	<1.0	0.00
		EP074_SR: Xylenes (Total)	----	1	mg/kg	<2.0	<2.0	0.00
EP-074_SR-I: Methyl-tert-butyl Ether (QC Lot: 3110256)								
HK2024063-007	Anonymous	EP074_SR: Methyl tert-Butyl Ether (MTBE)	1634-04-4	0.2	mg/kg	<0.2	<0.2	0.00
Matrix: WATER				Laboratory Duplicate (DUP) Report				
Laboratory sample ID	Client sample ID	Method: Compound	CAS Number	LOR	Unit	Original Result	Duplicate Result	RPD (%)
EG: Metals and Major Cations - Filtered (QC Lot: 3109624)								
HK2024008-003	Field Blank	EG020: Lead	7439-92-1	1	µg/L	<1	<1	0.00

Method Blank (MB), Laboratory Control Spike (LCS) and Laboratory Control Spike Duplicate (DCS) Report

Matrix: SOIL				Method Blank (MB) Report		Laboratory Control Spike (LCS) and Laboratory Control Spike Duplicate (DCS) Report					
Method: Compound	CAS Number	LOR	Unit	Result	Spike Concentration	Spike Recovery (%)		Recovery Limits(%)		RPD (%)	
						LCS	DCS	Low	High	Value	Control Limit
EG: Metals and Major Cations (QC Lot: 3109627)											
EG020: Lead	7439-92-1	1	mg/kg	<1	5 mg/kg	108	----	90.0	110	----	----
EP-076HK: Polycyclic Aromatic Hydrocarbons (PAHs) (QC Lot: 3107195)											
EP076HK: Naphthalene	91-20-3	50	µg/kg	<50	25 µg/kg	91.6	----	54.0	138	----	----
EP076HK: Acenaphthylene	208-96-8	50	µg/kg	<50	25 µg/kg	94.0	----	56.0	145	----	----
EP076HK: Acenaphthene	83-32-9	50	µg/kg	<50	25 µg/kg	90.0	----	54.0	139	----	----
EP076HK: Fluorene	86-73-7	50	µg/kg	<50	25 µg/kg	94.3	----	54.0	140	----	----
EP076HK: Phenanthrene	85-01-8	50	µg/kg	<50	25 µg/kg	93.8	----	51.0	139	----	----
EP076HK: Anthracene	120-12-7	50	µg/kg	<50	25 µg/kg	95.4	----	54.0	145	----	----
EP076HK: Fluoranthene	206-44-0	50	µg/kg	<50	25 µg/kg	95.4	----	55.0	142	----	----
EP076HK: Pyrene	129-00-0	50	µg/kg	<50	25 µg/kg	93.1	----	52.0	141	----	----
EP076HK: Benz(a)anthracene	56-55-3	50	µg/kg	<50	25 µg/kg	93.3	----	48.0	142	----	----
EP076HK: Chrysene	218-01-9	50	µg/kg	<50	25 µg/kg	91.0	----	49.0	146	----	----
EP076HK: Benzo(b)fluoranthene	205-99-2	50	µg/kg	<50	25 µg/kg	91.6	----	46.0	130	----	----



Matrix: SOIL		Method Blank (MB) Report			Laboratory Control Spike (LCS) and Laboratory Control Spike Duplicate (DCS) Report						
Method: Compound	CAS Number	LOR	Unit	Result	Spike Concentration	Spike Recovery (%)		Recovery Limits(%)		RPD (%)	
						LCS	DCS	Low	High	Value	Control Limit
EP-076HK: Polycyclic Aromatic Hydrocarbons (PAHs) (QC Lot: 3107195) - Continued											
EP076HK: Benzo(k)fluoranthene	207-08-9	50	µg/kg	<50	25 µg/kg	87.4	----	42.0	139	----	----
EP076HK: Benzo(a)pyrene	50-32-8	50	µg/kg	<50	25 µg/kg	86.8	----	26.0	140	----	----
EP076HK: Indeno(1.2.3.cd)pyrene	193-39-5	50	µg/kg	<50	25 µg/kg	69.2	----	25.0	126	----	----
EP076HK: Dibenz(a.h)anthracene	53-70-3	50	µg/kg	<50	25 µg/kg	66.3	----	27.0	130	----	----
EP076HK: Benzo(g,h,i)perylene	191-24-2	50	µg/kg	<50	25 µg/kg	61.6	----	15.0	138	----	----
EP-071HK_SR: Total Petroleum Hydrocarbons (TPH) (QC Lot: 3097063)											
EP071HK_SR: C9 - C16 Fraction	----	200	mg/kg	<200	31.5 mg/kg	87.2	----	79.0	102	----	----
EP071HK_SR: C17 - C35 Fraction	----	500	mg/kg	<500	67.5 mg/kg	75.0	----	59.0	101	----	----
EP-071HK_SR: Total Petroleum Hydrocarbons (TPH) (QC Lot: 3097064)											
EP070HK_SR: C6 - C8 Fraction	----	5	mg/kg	<5	4.5 mg/kg	89.4	----	80.0	123	----	----
EP-074_SR-A: Monocyclic Aromatic Hydrocarbons (MAH) (QC Lot: 3110256)											
EP074_SR: Benzene	71-43-2	0.1	mg/kg	<0.1	0.25 mg/kg	108	----	76.0	123	----	----
EP074_SR: Toluene	108-88-3	0.2	mg/kg	<0.2	0.25 mg/kg	110	----	79.0	121	----	----
EP074_SR: Ethylbenzene	100-41-4	0.2	mg/kg	<0.2	0.25 mg/kg	106	----	80.0	124	----	----
EP074_SR: meta- & para-Xylene	108-38-3	0.4	mg/kg	<0.4	0.5 mg/kg	106	----	83.0	121	----	----
	106-42-3										
EP074_SR: ortho-Xylene	95-47-6	0.2	mg/kg	<0.2	0.25 mg/kg	97.3	----	83.0	121	----	----
EP074_SR: Xylenes (Total)	----	1	mg/kg	<1.0	0.75 mg/kg	103	----	84.0	120	----	----
EP-074_SR-I: Methyl-tert-butyl Ether (QC Lot: 3110256)											
EP074_SR: Methyl tert-Butyl Ether (MTBE)	1634-04-4	0.2	mg/kg	<0.2	0.25 mg/kg	109	----	68.0	125	----	----
Matrix: WATER		Method Blank (MB) Report			Laboratory Control Spike (LCS) and Laboratory Control Spike Duplicate (DCS) Report						
Method: Compound	CAS Number	LOR	Unit	Result	Spike Concentration	Spike Recovery (%)		Recovery Limits(%)		RPD (%)	
						LCS	DCS	Low	High	Value	Control Limit
EG: Metals and Major Cations - Filtered (QC Lot: 3109624)											
EG020: Lead	7439-92-1	1	µg/L	<1	50 µg/L	110	----	85.0	113	----	----
EP-076HK: Polycyclic Aromatic Hydrocarbons (PAHs) (QC Lot: 3107249)											
EP076HK: Naphthalene	91-20-3	0.1	µg/L	<0.1	0.5 µg/L	90.1	----	66.0	135	----	----
EP076HK: Acenaphthylene	208-96-8	0.1	µg/L	<0.1	0.5 µg/L	85.0	----	60.0	136	----	----



Matrix: WATER		Method Blank (MB) Report			Laboratory Control Spike (LCS) and Laboratory Control Spike Duplicate (DCS) Report						
		LOR	Unit	Result	Spike Concentration	Spike Recovery (%)		Recovery Limits(%)		RPD (%)	
Method: Compound	CAS Number					LCS	DCS	Low	High	Value	Control Limit
EP-076HK: Polycyclic Aromatic Hydrocarbons (PAHs) (QC Lot: 3107249) - Continued											
EP076HK: Acenaphthene	83-32-9	0.1	µg/L	<0.1	0.5 µg/L	90.1	----	63.0	132	----	----
EP076HK: Fluorene	86-73-7	0.1	µg/L	<0.1	0.5 µg/L	89.8	----	64.0	135	----	----
EP076HK: Phenanthrene	85-01-8	0.1	µg/L	<0.1	0.5 µg/L	91.8	----	61.0	132	----	----
EP076HK: Anthracene	120-12-7	0.1	µg/L	<0.1	0.5 µg/L	88.8	----	61.0	121	----	----
EP076HK: Fluoranthene	206-44-0	0.1	µg/L	<0.1	0.5 µg/L	87.8	----	65.0	135	----	----
EP076HK: Pyrene	129-00-0	0.1	µg/L	<0.1	0.5 µg/L	86.1	----	61.0	136	----	----
EP076HK: Benz(a)anthracene	56-55-3	0.1	µg/L	<0.1	0.5 µg/L	80.3	----	64.0	124	----	----
EP076HK: Chrysene	218-01-9	0.1	µg/L	<0.1	0.5 µg/L	89.3	----	49.0	140	----	----
EP076HK: Benzo(b)fluoranthene	205-99-2	0.1	µg/L	<0.1	0.5 µg/L	82.7	----	53.0	135	----	----
EP076HK: Benzo(k)fluoranthene	207-08-9	0.1	µg/L	<0.1	0.5 µg/L	87.6	----	66.0	128	----	----
EP076HK: Benzo(a)pyrene	50-32-8	0.1	µg/L	<0.1	0.5 µg/L	76.8	----	45.0	126	----	----
EP076HK: Indeno(1.2.3.cd)pyrene	193-39-5	0.1	µg/L	<0.1	0.5 µg/L	77.5	----	45.0	129	----	----
EP076HK: Dibenz(a,h)anthracene	53-70-3	0.1	µg/L	<0.1	0.5 µg/L	78.0	----	47.0	130	----	----
EP076HK: Benzo(g,h,i)perylene	191-24-2	0.1	µg/L	<0.1	0.5 µg/L	84.6	----	42.0	140	----	----
EP-071HK_SR: Total Petroleum Hydrocarbons (TPH) (QC Lot: 3115268)											
EP071HK_SR: C9 - C16 Fraction	----	0.5	mg/L	<0.5	0.21 mg/L	101	----	71.0	121	----	----
EP071HK_SR: C17 - C35 Fraction	----	0.5	mg/L	<0.5	0.45 mg/L	93.7	----	68.0	103	----	----
EP-071HK_SR: Total Petroleum Hydrocarbons (TPH) (QC Lot: 3115975)											
EP070HK_SR: C6 - C8 Fraction	----	0.02	mg/L	<0.02	0.03 mg/L	106	----	77.0	120	----	----
EP-074_SR-A: Monocyclic Aromatic Hydrocarbons (MAH) (QC Lot: 3115976)											
EP074_SR: Benzene	71-43-2	0.5	µg/L	<0.5	2 µg/L	87.1	----	76.0	127	----	----
EP074_SR: Toluene	108-88-3	0.5	µg/L	<0.5	2 µg/L	85.8	----	77.0	125	----	----
EP074_SR: Ethylbenzene	100-41-4	0.5	µg/L	<0.5	2 µg/L	93.6	----	79.0	126	----	----
EP074_SR: meta- & para-Xylene	108-38-3 106-42-3	1	µg/L	<1	4 µg/L	90.6	----	79.0	121	----	----
EP074_SR: ortho-Xylene	95-47-6	0.5	µg/L	<0.5	2 µg/L	89.9	----	77.0	126	----	----
EP074_SR: Xylenes (Total)	----	2	µg/L	<2	6 µg/L	90.4	----	79.0	122	----	----
EP-074_SR-I: Methyl-tert-butyl Ether (QC Lot: 3115976)											
EP074_SR: Methyl tert-Butyl Ether (MTBE)	1634-04-4	0.5	µg/L	<0.5	2 µg/L	90.0	----	66.0	133	----	----



Matrix Spike (MS) and Matrix Spike Duplicate (MSD) Report

Matrix: SOIL

					Matrix Spike (MS) and Matrix Spike Duplicate (MSD) Report					
Laboratory sample ID	Client sample ID	Method: Compound	CAS Number	Spike Concentration	Spike Recovery (%)		Recovery Limits (%)		RPD (%)	
					MS	MSD	Low	High	Value	Control Limit
EG: Metals and Major Cations (QC Lot: 3109627)										
HK2024008-004	BH5-500MMBTS	EG020: Lead	7439-92-1	5 mg/kg	108	----	75.0	125	----	----
EP-076HK: Polycyclic Aromatic Hydrocarbons (PAHs) (QC Lot: 3107195)										
HK2023535-002	Anonymous	EP076HK: Naphthalene	91-20-3	250 µg/kg	88.3	----	50.0	130	----	----
		EP076HK: Acenaphthylene	208-96-8	250 µg/kg	91.4	----	50.0	130	----	----
		EP076HK: Acenaphthene	83-32-9	250 µg/kg	87.0	----	50.0	130	----	----
		EP076HK: Fluorene	86-73-7	250 µg/kg	89.6	----	50.0	130	----	----
		EP076HK: Phenanthrene	85-01-8	250 µg/kg	90.0	----	50.0	130	----	----
		EP076HK: Anthracene	120-12-7	250 µg/kg	94.7	----	50.0	130	----	----
		EP076HK: Fluoranthene	206-44-0	250 µg/kg	93.5	----	50.0	130	----	----
		EP076HK: Pyrene	129-00-0	250 µg/kg	95.2	----	50.0	130	----	----
		EP076HK: Benz(a)anthracene	56-55-3	250 µg/kg	90.4	----	50.0	130	----	----
		EP076HK: Chrysene	218-01-9	250 µg/kg	89.0	----	50.0	130	----	----
		EP076HK: Benzo(b)fluoranthene	205-99-2	250 µg/kg	89.6	----	50.0	130	----	----
		EP076HK: Benzo(k)fluoranthene	207-08-9	250 µg/kg	93.2	----	50.0	130	----	----
		EP076HK: Benzo(a)pyrene	50-32-8	250 µg/kg	94.0	----	50.0	130	----	----
		EP076HK: Indeno(1.2.3.cd)pyrene	193-39-5	250 µg/kg	84.0	----	50.0	130	----	----
		EP076HK: Dibenz(a,h)anthracene	53-70-3	250 µg/kg	73.6	----	50.0	130	----	----
		EP076HK: Benzo(g,h,i)perylene	191-24-2	250 µg/kg	83.2	----	50.0	130	----	----
EP-071HK_SR: Total Petroleum Hydrocarbons (TPH) (QC Lot: 3097063)										
HK2023240-002	Anonymous	EP071HK_SR: C9 - C16 Fraction	----	31.5 mg/kg	89.0	----	50.0	130	----	----
		EP071HK_SR: C17 - C35 Fraction	----	67.5 mg/kg	88.9	----	50.0	130	----	----
EP-071HK_SR: Total Petroleum Hydrocarbons (TPH) (QC Lot: 3097064)										
HK2023240-002	Anonymous	EP070HK_SR: C6 - C8 Fraction	----	4.5 mg/kg	97.6	----	50.0	130	----	----
EP-074_SR-A: Monocyclic Aromatic Hydrocarbons (MAH) (QC Lot: 3110256)										
HK2024005-005	Anonymous	EP074_SR: Benzene	71-43-2	0.25 mg/kg	100	----	50.0	130	----	----
		EP074_SR: Toluene	108-88-3	0.25 mg/kg	115	----	50.0	130	----	----
		EP074_SR: Ethylbenzene	100-41-4	0.25 mg/kg	112	----	50.0	130	----	----



Matrix: SOIL				<i>Matrix Spike (MS) and Matrix Spike Duplicate (MSD) Report</i>						
Laboratory sample ID	Client sample ID	Method: Compound	CAS Number	Spike Concentration	Spike Recovery (%)		Recovery Limits (%)		RPD (%)	
					MS	MSD	Low	High	Value	Control Limit
EP-074_SR-A: Monocyclic Aromatic Hydrocarbons (MAH) (QC Lot: 3110256) - Continued										
HK2024005-005	Anonymous	EP074_SR: meta- & para-Xylene	108-38-3 106-42-3	0.5 mg/kg	110	----	50.0	130	----	----
		EP074_SR: ortho-Xylene	95-47-6	0.25 mg/kg	110	----	50.0	130	----	----
		EP074_SR: Xylenes (Total)	----	0.75 mg/kg	110	----	50.0	130	----	----
EP-074_SR-I: Methyl-tert-butyl Ether (QC Lot: 3110256)										
HK2024005-005	Anonymous	EP074_SR: Methyl tert-Butyl Ether (MTBE)	1634-04-4	0.25 mg/kg	102	----	50.0	130	----	----

Matrix: WATER				<i>Matrix Spike (MS) and Matrix Spike Duplicate (MSD) Report</i>						
Laboratory sample ID	Client sample ID	Method: Compound	CAS Number	Spike Concentration	Spike Recovery (%)		Recovery Limits (%)		RPD (%)	
					MS	MSD	Low	High	Value	Control Limit
EG: Metals and Major Cations - Filtered (QC Lot: 3109624)										
HK2024008-002	Equipment Blank	EG020: Lead	7439-92-1	50 µg/L	112	----	75.0	125	----	----

Surrogate Control Limits

Sub-Matrix: SOIL		Recovery Limits (%)	
Compound	CAS Number	Low	High
EP-076S: Polycyclic Aromatics Hydrocarbons (PAHs) Surrogates			
2-Fluorobiphenyl	321-60-8	50	130
4-Terphenyl-d14	1718-51-0	50	130
EP-080_SRS: TPH(Volatile)/BTEX Surrogate			
Dibromofluoromethane	1868-53-7	80	120
Toluene-D8	2037-26-5	81	117
4-Bromofluorobenzene	460-00-4	74	121
EP-074_SR-S: VOC Surrogates			
Dibromofluoromethane	1868-53-7	80	120
Toluene-D8	2037-26-5	81	117
4-Bromofluorobenzene	460-00-4	74	121



Sub-Matrix: WATER		Recovery Limits (%)	
Compound	CAS Number	Low	High
EP-076S: Polycyclic Aromatics Hydrocarbons (PAHs) Surrogates			
2-Fluorobiphenyl	321-60-8	50	130
4-Terphenyl-d14	1718-51-0	50	130
EP-080_SRS: TPH(Volatile)/BTEX Surrogate			
Dibromofluoromethane	1868-53-7	86	118
Toluene-D8	2037-26-5	88	110
4-Bromofluorobenzene	460-00-4	86	115
EP-074_SR-S: VOC Surrogates			
Dibromofluoromethane	1868-53-7	86	118
Toluene-D8	2037-26-5	88	110
4-Bromofluorobenzene	460-00-4	86	115



CERTIFICATE OF ANALYSIS





Client	: MOTT MACDONALD HONG KONG LIMITED	Laboratory	: ALS Technichem (HK) Pty Ltd	Page	: 1 of 15
Contact	: THOMAS CHAN	Contact	: Richard Fung	Work Order	: HK2027733
Address	: 3/F INTERNATIONAL TRADE TOWER, 348 KWUN TONG ROAD, KWUN TONG, KOWLOON, HONG KONG	Address	: 11/F., Chung Shun Knitting Centre, 1 - 3 Wing Yip Street, Kwai Chung, N.T., Hong Kong		
E-mail	: thomas.chan@mottmac.com	E-mail	: richard.fung@alsglobal.com		
Telephone	: +852 2828 5933	Telephone	: +852 2610 1044	Date Samples Received	: 24-Jul-2020
Facsimile	: +852 2828 1823	Facsimile	: +852 2610 2021	Issue Date	: 04-Aug-2020
Project	: SOIL TESTING AT HONG KONG AIRPORT			No. of samples received	: 6
Order number	: ---	Quote	: HKE/1861c/2018_V2	No. of samples analysed	: 6
		number			
C-O-C number	: H030965				
Site	: CONTRACT NO. C3503 TERMINAL 2 FOUNDATION AND SUBSTRUCTURE WORKS				



This report may not be reproduced except with prior written approval from the testing laboratory.

Hong Kong Accreditation Service (HKAS) has accredited this laboratory, ALS Technichem (HK) Pty Ltd (Reg. No. HOKLAS 066) under Hong Kong Laboratory Accreditation Scheme (HOKLAS) for specific laboratory activities as listed in the HOKLAS Directory of Accredited Laboratories.

This document has been signed by those names that appear on this report and are the authorised signatories.

<i>Signatories</i>	<i>Position</i>	<i>Authorised results for</i>
 Anh Ngoc Huynh .	Senior Chemist	Organics_ENV
 Chan Siu Ming , Vico	Manager - Inorganics	Inorganics
 Leung Chak Cheong , Mike	Senior Chemist	Metals_ENV
 Wong Wing , Kenneth	Manager - Metals	Metals_ENV



General Comments

This report supersedes any previous report(s) with this reference. All pages of this report have been checked and approved for release. When sampling time information is not provided by the client, sampling dates are shown without a time component. In these instances, the time component has been assumed by the laboratory for processing purposes. Testing period is from 24-Jul-2020 to 04-Aug-2020.

Key: LOR = Limit of reporting; CAS Number = CAS registry number from database maintained by Chemical Abstracts Services. The Chemical Abstracts Service is a division of the American Chemical Society.

Specific Comments for Work Order: HK2027733

Sample(s) was/ were submitted by client. Sample(s) arrived laboratory in chilled condition. The result(s) related only to the item(s) tested.

Sample information (Project name, Sample ID, Sampling date/time, etc., if any) is provided by client.

Result(s) of soil/sediment sample(s) was / were reported on dry weight basis.

EP070 is the numeric code for internal use. Test method for C6-C9 Fraction of TPH is EP071.

Sample(s) as received, digested by In-house method E-ASTM D3974-09 prior to determination of metals. The In-house method is developed based on ASTM D3974-09 method.



Analytical Results

Sub-Matrix: SOIL

Client sample ID

Client sampling date / time

				BH6-NLTS1	BH6-S1	BH6-S4	BH6-S5	BH6-S6
				24-Jul-2020	24-Jul-2020	24-Jul-2020	24-Jul-2020	24-Jul-2020
Compound	CAS Number	LOR	Unit	HK2027733-002	HK2027733-003	HK2027733-004	HK2027733-005	HK2027733-006
EA/ED: Physical and Aggregate Properties								
EA055: Moisture Content (dried @ 103°C)	----	0.1	%	11.2	10.6	11.1	10.8	4.8
EG: Metals and Major Cations								
EG020: Lead	7439-92-1	1	mg/kg	62	76	209	71	104
EP-076HK: Polycyclic Aromatic Hydrocarbons (PAHs)								
EP076HK: Naphthalene	91-20-3	0.500	mg/kg	<0.500	<0.500	<0.500	<0.500	<0.500
EP076HK: Acenaphthylene	208-96-8	0.500	mg/kg	<0.500	<0.500	<0.500	<0.500	<0.500
EP076HK: Acenaphthene	83-32-9	0.500	mg/kg	<0.500	<0.500	<0.500	<0.500	<0.500
EP076HK: Fluorene	86-73-7	0.500	mg/kg	<0.500	<0.500	<0.500	<0.500	<0.500
EP076HK: Phenanthrene	85-01-8	0.500	mg/kg	<0.500	<0.500	<0.500	<0.500	<0.500
EP076HK: Anthracene	120-12-7	0.500	mg/kg	<0.500	<0.500	<0.500	<0.500	<0.500
EP076HK: Fluoranthene	206-44-0	0.500	mg/kg	<0.500	<0.500	<0.500	<0.500	<0.500
EP076HK: Pyrene	129-00-0	0.500	mg/kg	<0.500	<0.500	<0.500	<0.500	<0.500
EP076HK: Benz(a)anthracene	56-55-3	0.500	mg/kg	<0.500	<0.500	<0.500	<0.500	<0.500
EP076HK: Chrysene	218-01-9	0.500	mg/kg	<0.500	<0.500	<0.500	<0.500	<0.500
EP076HK: Benzo(b)fluoranthene	205-99-2	0.500	mg/kg	<0.500	<0.500	<0.500	<0.500	<0.500
EP076HK: Benzo(k)fluoranthene	207-08-9	0.500	mg/kg	<0.500	<0.500	<0.500	<0.500	<0.500
EP076HK: Benzo(a)pyrene	50-32-8	0.500	mg/kg	<0.500	<0.500	<0.500	<0.500	<0.500
EP076HK: Indeno(1.2.3.cd)pyrene	193-39-5	0.500	mg/kg	<0.500	<0.500	<0.500	<0.500	<0.500
EP076HK: Dibenz(a,h)anthracene	53-70-3	0.500	mg/kg	<0.500	<0.500	<0.500	<0.500	<0.500
EP076HK: Benzo(g,h,i)perylene	191-24-2	0.500	mg/kg	<0.500	<0.500	<0.500	<0.500	<0.500
EP-071HK_SR: Total Petroleum Hydrocarbons (TPH)								
EP070HK_SR: C6 - C8 Fraction	----	5	mg/kg	<5	<5	<5	<5	<5
EP071HK_SR: C9 - C16 Fraction	----	200	mg/kg	<200	<200	<200	<200	<200
EP071HK_SR: C17 - C35 Fraction	----	500	mg/kg	<500	<500	<500	<500	<500
EP-074_SR-A: Monocyclic Aromatic Hydrocarbons (MAH)								
EP074_SR: Benzene	71-43-2	0.2	mg/kg	<0.2	<0.2	<0.2	<0.2	<0.2
EP074_SR: Toluene	108-88-3	0.5	mg/kg	<0.5	<0.5	<0.5	<0.5	<0.5
EP074_SR: Ethylbenzene	100-41-4	0.5	mg/kg	<0.5	<0.5	<0.5	<0.5	<0.5



Sub-Matrix: SOIL				BH6-NLTS1	BH6-S1	BH6-S4	BH6-S5	BH6-S6
Client sample ID				24-Jul-2020	24-Jul-2020	24-Jul-2020	24-Jul-2020	24-Jul-2020
Client sampling date / time				24-Jul-2020	24-Jul-2020	24-Jul-2020	24-Jul-2020	24-Jul-2020
Compound	CAS Number	LOR	Unit	HK2027733-002	HK2027733-003	HK2027733-004	HK2027733-005	HK2027733-006
EP-074_SR-A: Monocyclic Aromatic Hydrocarbons (MAH) - Continued								
EP074_SR: meta- & para-Xylene	108-38-3 106-42-3	1.0	mg/kg	<1.0	<1.0	<1.0	<1.0	<1.0
EP074_SR: ortho-Xylene	95-47-6	0.5	mg/kg	<0.5	<0.5	<0.5	<0.5	<0.5
EP074_SR: Xylenes (Total)	----	2.0	mg/kg	<2.0	<2.0	<2.0	<2.0	<2.0
EP-074_SR-I: Methyl-tert-butyl Ether								
EP074_SR: Methyl tert-Butyl Ether (MTBE)	1634-04-4	0.2	mg/kg	<0.2	<0.2	<0.2	<0.2	<0.2
EP-076S: Polycyclic Aromatics Hydrocarbons (PAHs) Surrogates								
EP076HK: 2-Fluorobiphenyl	321-60-8	0.1	%	98.8	96.0	95.6	95.3	92.5
EP076HK: 4-Terphenyl-d14	1718-51-0	0.1	%	100	95.5	96.1	97.5	100
EP-080_SRS: TPH(Volatile)/BTEX Surrogate								
EP070HK_SR: Dibromofluoromethane	1868-53-7	0.1	%	92.5	91.7	94.2	93.8	92.6
EP070HK_SR: Toluene-D8	2037-26-5	0.1	%	98.7	98.1	96.8	95.6	95.6
EP070HK_SR: 4-Bromofluorobenzene	460-00-4	0.1	%	95.5	95.1	96.4	94.8	94.4
EP-074_SR-S: VOC Surrogates								
EP074_SR: Dibromofluoromethane	1868-53-7	0.1	%	92.5	91.7	94.2	93.8	92.6
EP074_SR: Toluene-D8	2037-26-5	0.1	%	98.7	98.1	96.8	95.6	95.6
EP074_SR: 4-Bromofluorobenzene	460-00-4	0.1	%	95.5	95.1	96.4	94.8	94.4



Sub-Matrix: WATER				Client sample ID	Trip Blank	---	---	---	---
				Client sampling date / time	24-Jul-2020	---	---	---	---
Compound	CAS Number	LOR	Unit	HK2027733-001	---	---	---	---	---
EP-071HK_SR: Total Petroleum Hydrocarbons (TPH)									
EP070HK_SR: C6 - C8 Fraction	----	20	µg/L	<20	---	---	---	---	---
EP-074_SR-A: Monocyclic Aromatic Hydrocarbons (MAH)									
EP074_SR: Benzene	71-43-2	5.0	µg/L	<5.0	---	---	---	---	---
EP074_SR: Toluene	108-88-3	5.0	µg/L	<5.0	---	---	---	---	---
EP074_SR: Ethylbenzene	100-41-4	5.0	µg/L	<5.0	---	---	---	---	---
EP074_SR: meta- & para-Xylene	108-38-3 106-42-3	10	µg/L	<10	---	---	---	---	---
EP074_SR: ortho-Xylene	95-47-6	5.0	µg/L	<5.0	---	---	---	---	---
EP074_SR: Xylenes (Total)	----	20	µg/L	<20	---	---	---	---	---
EP-074_SR-I: Methyl-tert-butyl Ether									
EP074_SR: Methyl tert-Butyl Ether (MTBE)	1634-04-4	0.5	µg/L	<0.5	---	---	---	---	---
EP-080_SRS: TPH(Volatile)/BTEX Surrogate									
EP070HK_SR: Dibromofluoromethane	1868-53-7	0.1	%	90.8	---	---	---	---	---
EP070HK_SR: Toluene-D8	2037-26-5	0.1	%	101	---	---	---	---	---
EP070HK_SR: 4-Bromofluorobenzene	460-00-4	0.1	%	93.5	---	---	---	---	---
EP-074_SR-S: VOC Surrogates									
EP074_SR: Dibromofluoromethane	1868-53-7	0.1	%	90.8	---	---	---	---	---
EP074_SR: Toluene-D8	2037-26-5	0.1	%	101	---	---	---	---	---
EP074_SR: 4-Bromofluorobenzene	460-00-4	0.1	%	93.5	---	---	---	---	---



Laboratory Duplicate (DUP) Report

Matrix: SOIL

Laboratory Duplicate (DUP) Report

Laboratory sample ID	Client sample ID	Method: Compound	CAS Number	LOR	Unit	Original Result	Duplicate Result	RPD (%)
EA/ED: Physical and Aggregate Properties (QC Lot: 3162752)								
HK2027646-001	Anonymous	EA055: Moisture Content (dried @ 103°C)	----	0.1	%	20.2	20.0	1.10
HK2027733-006	BH6-S6	EA055: Moisture Content (dried @ 103°C)	----	0.1	%	4.8	4.9	0.00
EG: Metals and Major Cations (QC Lot: 3162948)								
HK2027733-002	BH6-NLTS1	EG020: Lead	7439-92-1	1	mg/kg	62	61	0.00
EP-076HK: Polycyclic Aromatic Hydrocarbons (PAHs) (QC Lot: 3151538)								
HK2027136-001	Anonymous	EP076HK: Naphthalene	91-20-3	50	µg/kg	<0.500 mg/kg	<500	0.00
		EP076HK: Acenaphthylene	208-96-8	50	µg/kg	<0.500 mg/kg	<500	0.00
		EP076HK: Acenaphthene	83-32-9	50	µg/kg	<0.500 mg/kg	<500	0.00
		EP076HK: Fluorene	86-73-7	50	µg/kg	<0.500 mg/kg	<500	0.00
		EP076HK: Phenanthrene	85-01-8	50	µg/kg	<0.500 mg/kg	<500	0.00
		EP076HK: Anthracene	120-12-7	50	µg/kg	<0.500 mg/kg	<500	0.00
		EP076HK: Fluoranthene	206-44-0	50	µg/kg	0.576 mg/kg	562	2.51
		EP076HK: Pyrene	129-00-0	50	µg/kg	0.575 mg/kg	552	4.03
		EP076HK: Benz(a)anthracene	56-55-3	50	µg/kg	<0.500 mg/kg	<500	0.00
		EP076HK: Chrysene	218-01-9	50	µg/kg	<0.500 mg/kg	<500	0.00
		EP076HK: Benzo(b)fluoranthene	205-99-2	50	µg/kg	<0.500 mg/kg	<500	0.00
		EP076HK: Benzo(k)fluoranthene	207-08-9	50	µg/kg	<0.500 mg/kg	<500	0.00
		EP076HK: Benzo(a)pyrene	50-32-8	50	µg/kg	<0.500 mg/kg	<500	0.00
		EP076HK: Indeno(1.2.3.cd)pyrene	193-39-5	50	µg/kg	<0.500 mg/kg	<500	0.00
EP076HK: Dibenz(a,h)anthracene	53-70-3	50	µg/kg	<0.500 mg/kg	<500	0.00		
EP076HK: Benzo(g,h,i)perylene	191-24-2	50	µg/kg	<0.500 mg/kg	<500	0.00		
EP-076HK: Polycyclic Aromatic Hydrocarbons (PAHs) (QC Lot: 3160526)								
HK2027733-004	BH6-S4	EP076HK: Naphthalene	91-20-3	50	µg/kg	<0.500 mg/kg	<500	0.00
		EP076HK: Acenaphthylene	208-96-8	50	µg/kg	<0.500 mg/kg	<500	0.00
		EP076HK: Acenaphthene	83-32-9	50	µg/kg	<0.500 mg/kg	<500	0.00
		EP076HK: Fluorene	86-73-7	50	µg/kg	<0.500 mg/kg	<500	0.00
		EP076HK: Phenanthrene	85-01-8	50	µg/kg	<0.500 mg/kg	<500	0.00
		EP076HK: Anthracene	120-12-7	50	µg/kg	<0.500 mg/kg	<500	0.00
		EP076HK: Fluoranthene	206-44-0	50	µg/kg	<0.500 mg/kg	<500	0.00
		EP076HK: Pyrene	129-00-0	50	µg/kg	<0.500 mg/kg	<500	0.00



Matrix: SOIL				Laboratory Duplicate (DUP) Report				
Laboratory sample ID	Client sample ID	Method: Compound	CAS Number	LOR	Unit	Original Result	Duplicate Result	RPD (%)
EP-076HK: Polycyclic Aromatic Hydrocarbons (PAHs) (QC Lot: 3160526) - Continued								
HK2027733-004	BH6-S4	EP076HK: Benz(a)anthracene	56-55-3	50	µg/kg	<0.500 mg/kg	<500	0.00
		EP076HK: Chrysene	218-01-9	50	µg/kg	<0.500 mg/kg	<500	0.00
		EP076HK: Benzo(b)fluoranthene	205-99-2	50	µg/kg	<0.500 mg/kg	<500	0.00
		EP076HK: Benzo(k)fluoranthene	207-08-9	50	µg/kg	<0.500 mg/kg	<500	0.00
		EP076HK: Benzo(a)pyrene	50-32-8	50	µg/kg	<0.500 mg/kg	<500	0.00
		EP076HK: Indeno(1.2.3.cd)pyrene	193-39-5	50	µg/kg	<0.500 mg/kg	<500	0.00
		EP076HK: Dibenz(a,h)anthracene	53-70-3	50	µg/kg	<0.500 mg/kg	<500	0.00
		EP076HK: Benzo(g,h,i)perylene	191-24-2	50	µg/kg	<0.500 mg/kg	<500	0.00
EP-071HK_SR: Total Petroleum Hydrocarbons (TPH) (QC Lot: 3159803)								
HK2027649-001	Anonymous	EP071HK_SR: C9 - C16 Fraction	----	200	mg/kg	<200	<200	0.00
		EP071HK_SR: C17 - C35 Fraction	----	500	mg/kg	<500	<500	0.00
EP-071HK_SR: Total Petroleum Hydrocarbons (TPH) (QC Lot: 3159804)								
HK2027649-001	Anonymous	EP070HK_SR: C6 - C8 Fraction	----	5	mg/kg	<5	<5	0.00
EP-074_SR-A: Monocyclic Aromatic Hydrocarbons (MAH) (QC Lot: 3151540)								
HK2027136-001	Anonymous	EP074_SR: Benzene	71-43-2	0.1	mg/kg	<0.2	<0.2	0.00
		EP074_SR: Toluene	108-88-3	0.2	mg/kg	<0.5	<0.5	0.00
		EP074_SR: Ethylbenzene	100-41-4	0.2	mg/kg	<0.5	<0.5	0.00
		EP074_SR: ortho-Xylene	95-47-6	0.2	mg/kg	<0.5	<0.5	0.00
		EP074_SR: meta- & para-Xylene	108-38-3	0.4	mg/kg	<1.0	<1.0	0.00
			106-42-3	----	1	mg/kg	<2.0	<2.0
EP-074_SR-A: Monocyclic Aromatic Hydrocarbons (MAH) (QC Lot: 3160527)								
HK2027733-004	BH6-S4	EP074_SR: Benzene	71-43-2	0.1	mg/kg	<0.2	<0.2	0.00
		EP074_SR: Toluene	108-88-3	0.2	mg/kg	<0.5	<0.5	0.00
		EP074_SR: Ethylbenzene	100-41-4	0.2	mg/kg	<0.5	<0.5	0.00
		EP074_SR: ortho-Xylene	95-47-6	0.2	mg/kg	<0.5	<0.5	0.00
		EP074_SR: meta- & para-Xylene	108-38-3	0.4	mg/kg	<1.0	<1.0	0.00
			106-42-3	----	1	mg/kg	<2.0	<2.0
EP-074_SR-I: Methyl-tert-butyl Ether (QC Lot: 3151540)								
HK2027136-001	Anonymous	EP074_SR: Methyl tert-Butyl Ether (MTBE)	1634-04-4	0.2	mg/kg	<0.5	<0.5	0.00



Matrix: SOIL				Laboratory Duplicate (DUP) Report				
Laboratory sample ID	Client sample ID	Method: Compound	CAS Number	LOR	Unit	Original Result	Duplicate Result	RPD (%)
EP-074_SR-I: Methyl-tert-butyl Ether (QC Lot: 3160527)								
HK2027733-004	BH6-S4	EP074_SR: Methyl tert-Butyl Ether (MTBE)	1634-04-4	0.2	mg/kg	<0.2	<0.2	0.00

Method Blank (MB), Laboratory Control Spike (LCS) and Laboratory Control Spike Duplicate (DCS) Report

Matrix: SOIL		Method Blank (MB) Report			Laboratory Control Spike (LCS) and Laboratory Control Spike Duplicate (DCS) Report							
Method: Compound	CAS Number	LOR	Unit	Result	Spike Concentration	Spike Recovery (%)		Recovery Limits(%)		RPD (%)		
						LCS	DCS	Low	High	Value	Control Limit	
EG: Metals and Major Cations (QC Lot: 3162948)												
EG020: Lead	7439-92-1	1	mg/kg	<1	5 mg/kg	99.4	----	90.0	110	----	----	
EP-076HK: Polycyclic Aromatic Hydrocarbons (PAHs) (QC Lot: 3151538)												
EP076HK: Naphthalene	91-20-3	50	µg/kg	<50	25 µg/kg	93.0	----	54.0	138	----	----	
EP076HK: Acenaphthylene	208-96-8	50	µg/kg	<50	25 µg/kg	95.3	----	56.0	145	----	----	
EP076HK: Acenaphthene	83-32-9	50	µg/kg	<50	25 µg/kg	90.8	----	54.0	139	----	----	
EP076HK: Fluorene	86-73-7	50	µg/kg	<50	25 µg/kg	90.6	----	54.0	140	----	----	
EP076HK: Phenanthrene	85-01-8	50	µg/kg	<50	25 µg/kg	95.6	----	51.0	139	----	----	
EP076HK: Anthracene	120-12-7	50	µg/kg	<50	25 µg/kg	97.2	----	54.0	145	----	----	
EP076HK: Fluoranthene	206-44-0	50	µg/kg	<50	25 µg/kg	94.5	----	55.0	142	----	----	
EP076HK: Pyrene	129-00-0	50	µg/kg	<50	25 µg/kg	92.9	----	52.0	141	----	----	
EP076HK: Benz(a)anthracene	56-55-3	50	µg/kg	<50	25 µg/kg	89.3	----	48.0	142	----	----	
EP076HK: Chrysene	218-01-9	50	µg/kg	<50	25 µg/kg	91.2	----	49.0	146	----	----	
EP076HK: Benzo(b)fluoranthene	205-99-2	50	µg/kg	<50	25 µg/kg	93.5	----	46.0	130	----	----	
EP076HK: Benzo(k)fluoranthene	207-08-9	50	µg/kg	<50	25 µg/kg	84.3	----	42.0	139	----	----	
EP076HK: Benzo(a)pyrene	50-32-8	50	µg/kg	<50	25 µg/kg	86.5	----	26.0	140	----	----	
EP076HK: Indeno(1.2.3.cd)pyrene	193-39-5	50	µg/kg	<50	25 µg/kg	80.7	----	25.0	126	----	----	
EP076HK: Dibenz(a,h)anthracene	53-70-3	50	µg/kg	<50	25 µg/kg	77.6	----	27.0	130	----	----	
EP076HK: Benzo(g,h,i)perylene	191-24-2	50	µg/kg	<50	25 µg/kg	81.2	----	15.0	138	----	----	
EP-076HK: Polycyclic Aromatic Hydrocarbons (PAHs) (QC Lot: 3160526)												
EP076HK: Naphthalene	91-20-3	50	µg/kg	<50	25 µg/kg	109	----	54.0	138	----	----	
EP076HK: Acenaphthylene	208-96-8	50	µg/kg	<50	25 µg/kg	107	----	56.0	145	----	----	
EP076HK: Acenaphthene	83-32-9	50	µg/kg	<50	25 µg/kg	104	----	54.0	139	----	----	
EP076HK: Fluorene	86-73-7	50	µg/kg	<50	25 µg/kg	105	----	54.0	140	----	----	



Matrix: SOIL		Method Blank (MB) Report			Laboratory Control Spike (LCS) and Laboratory Control Spike Duplicate (DCS) Report								
		Method: Compound	CAS Number	LOR	Unit	Result	Spike Concentration	Spike Recovery (%)		Recovery Limits(%)		RPD (%)	
								LCS	DCS	Low	High	Value	Control Limit
EP-076HK: Polycyclic Aromatic Hydrocarbons (PAHs) (QC Lot: 3160526) - Continued													
EP076HK: Phenanthrene	85-01-8	50	µg/kg	<50	25 µg/kg	111	----	51.0	139	----	----		
EP076HK: Anthracene	120-12-7	50	µg/kg	<50	25 µg/kg	109	----	54.0	145	----	----		
EP076HK: Fluoranthene	206-44-0	50	µg/kg	<50	25 µg/kg	109	----	55.0	142	----	----		
EP076HK: Pyrene	129-00-0	50	µg/kg	<50	25 µg/kg	108	----	52.0	141	----	----		
EP076HK: Benz(a)anthracene	56-55-3	50	µg/kg	<50	25 µg/kg	101	----	48.0	142	----	----		
EP076HK: Chrysene	218-01-9	50	µg/kg	<50	25 µg/kg	108	----	49.0	146	----	----		
EP076HK: Benzo(b)fluoranthene	205-99-2	50	µg/kg	<50	25 µg/kg	99.6	----	46.0	130	----	----		
EP076HK: Benzo(k)fluoranthene	207-08-9	50	µg/kg	<50	25 µg/kg	101	----	42.0	139	----	----		
EP076HK: Benzo(a)pyrene	50-32-8	50	µg/kg	<50	25 µg/kg	94.4	----	26.0	140	----	----		
EP076HK: Indeno(1.2.3.cd)pyrene	193-39-5	50	µg/kg	<50	25 µg/kg	80.6	----	25.0	126	----	----		
EP076HK: Dibenz(a,h)anthracene	53-70-3	50	µg/kg	<50	25 µg/kg	87.3	----	27.0	130	----	----		
EP076HK: Benzo(g,h,i)perylene	191-24-2	50	µg/kg	<50	25 µg/kg	96.9	----	15.0	138	----	----		
EP-071HK_SR: Total Petroleum Hydrocarbons (TPH) (QC Lot: 3159803)													
EP071HK_SR: C9 - C16 Fraction	----	200	mg/kg	<200	31.5 mg/kg	95.0	----	79.0	102	----	----		
EP071HK_SR: C17 - C35 Fraction	----	500	mg/kg	<500	67.5 mg/kg	86.9	----	59.0	101	----	----		
EP-071HK_SR: Total Petroleum Hydrocarbons (TPH) (QC Lot: 3159804)													
EP070HK_SR: C6 - C8 Fraction	----	5	mg/kg	<5	4.5 mg/kg	105	----	77.0	124	----	----		
EP-074_SR-A: Monocyclic Aromatic Hydrocarbons (MAH) (QC Lot: 3151540)													
EP074_SR: Benzene	71-43-2	0.1	mg/kg	<0.1	0.25 mg/kg	106	----	80.0	123	----	----		
EP074_SR: Toluene	108-88-3	0.2	mg/kg	<0.2	0.25 mg/kg	108	----	83.0	126	----	----		
EP074_SR: Ethylbenzene	100-41-4	0.2	mg/kg	<0.2	0.25 mg/kg	111	----	80.0	125	----	----		
EP074_SR: meta- & para-Xylene	108-38-3 106-42-3	0.4	mg/kg	<0.4	0.5 mg/kg	104	----	82.0	124	----	----		
EP074_SR: ortho-Xylene	95-47-6	0.2	mg/kg	<0.2	0.25 mg/kg	102	----	79.0	128	----	----		
EP074_SR: Xylenes (Total)	----	1	mg/kg	<1.0	0.75 mg/kg	103	----	82.0	124	----	----		
EP-074_SR-A: Monocyclic Aromatic Hydrocarbons (MAH) (QC Lot: 3160527)													
EP074_SR: Benzene	71-43-2	0.1	mg/kg	<0.1	0.25 mg/kg	98.3	----	80.0	123	----	----		
EP074_SR: Toluene	108-88-3	0.2	mg/kg	<0.2	0.25 mg/kg	106	----	83.0	126	----	----		
EP074_SR: Ethylbenzene	100-41-4	0.2	mg/kg	<0.2	0.25 mg/kg	108	----	80.0	125	----	----		



Matrix: SOIL		Method Blank (MB) Report			Laboratory Control Spike (LCS) and Laboratory Control Spike Duplicate (DCS) Report						
Method: Compound	CAS Number	LOR	Unit	Result	Spike Concentration	Spike Recovery (%)		Recovery Limits(%)		RPD (%)	
						LCS	DCS	Low	High	Value	Control Limit
EP-074_SR-A: Monocyclic Aromatic Hydrocarbons (MAH) (QC Lot: 3160527) - Continued											
EP074_SR: meta- & para-Xylene	108-38-3	0.4	mg/kg	<0.4	0.5 mg/kg	110	----	82.0	124	----	----
	106-42-3										
EP074_SR: ortho-Xylene	95-47-6	0.2	mg/kg	<0.2	0.25 mg/kg	110	----	79.0	128	----	----
EP074_SR: Xylenes (Total)	----	1	mg/kg	<1.0	0.75 mg/kg	110	----	82.0	124	----	----
EP-074_SR-I: Methyl-tert-butyl Ether (QC Lot: 3151540)											
EP074_SR: Methyl tert-Butyl Ether (MTBE)	1634-04-4	0.2	mg/kg	<0.2	0.25 mg/kg	105	----	78.0	126	----	----
EP-074_SR-I: Methyl-tert-butyl Ether (QC Lot: 3160527)											
EP074_SR: Methyl tert-Butyl Ether (MTBE)	1634-04-4	0.2	mg/kg	<0.2	0.25 mg/kg	90.9	----	78.0	126	----	----
Matrix: WATER		Method Blank (MB) Report			Laboratory Control Spike (LCS) and Laboratory Control Spike Duplicate (DCS) Report						
Method: Compound	CAS Number	LOR	Unit	Result	Spike Concentration	Spike Recovery (%)		Recovery Limits(%)		RPD (%)	
						LCS	DCS	Low	High	Value	Control Limit
EP-071HK_SR: Total Petroleum Hydrocarbons (TPH) (QC Lot: 3154099)											
EP070HK_SR: C6 - C8 Fraction	----	0.02	mg/L	<0.02	0.03 mg/L	101	----	77.0	120	----	----
EP-074_SR-A: Monocyclic Aromatic Hydrocarbons (MAH) (QC Lot: 3154940)											
EP074_SR: Benzene	71-43-2	0.5	µg/L	<0.5	2 µg/L	91.6	----	76.0	125	----	----
EP074_SR: Toluene	108-88-3	0.5	µg/L	<0.5	2 µg/L	91.2	----	78.0	126	----	----
EP074_SR: Ethylbenzene	100-41-4	0.5	µg/L	<0.5	2 µg/L	92.7	----	81.0	120	----	----
EP074_SR: meta- & para-Xylene	108-38-3	1	µg/L	<1	4 µg/L	97.8	----	77.0	125	----	----
	106-42-3										
EP074_SR: ortho-Xylene	95-47-6	0.5	µg/L	<0.5	2 µg/L	92.7	----	77.0	125	----	----
EP074_SR: Xylenes (Total)	----	2	µg/L	<2	6 µg/L	96.1	----	79.0	123	----	----
EP-074_SR-I: Methyl-tert-butyl Ether (QC Lot: 3154940)											
EP074_SR: Methyl tert-Butyl Ether (MTBE)	1634-04-4	0.5	µg/L	<0.5	2 µg/L	100	----	78.0	128	----	----



Matrix Spike (MS) and Matrix Spike Duplicate (MSD) Report

Matrix: SOIL

					Matrix Spike (MS) and Matrix Spike Duplicate (MSD) Report					
Laboratory sample ID	Client sample ID	Method: Compound	CAS Number	Spike Concentration	Spike Recovery (%)		Recovery Limits (%)		RPD (%)	
					MS	MSD	Low	High	Value	Control Limit
EG: Metals and Major Cations (QC Lot: 3162948)										
HK2027683-001	Anonymous	EG020: Lead	7439-92-1	5 mg/kg	98.2	----	75.0	125	----	----
EP-076HK: Polycyclic Aromatic Hydrocarbons (PAHs) (QC Lot: 3151538)										
HK2027136-001	Anonymous	EP076HK: Naphthalene	91-20-3	250 µg/kg	102	----	50.0	130	----	----
		EP076HK: Acenaphthylene	208-96-8	250 µg/kg	97.6	----	50.0	130	----	----
		EP076HK: Acenaphthene	83-32-9	250 µg/kg	96.0	----	50.0	130	----	----
		EP076HK: Fluorene	86-73-7	250 µg/kg	96.7	----	50.0	130	----	----
		EP076HK: Phenanthrene	85-01-8	250 µg/kg	72.5	----	50.0	130	----	----
		EP076HK: Anthracene	120-12-7	250 µg/kg	102	----	50.0	130	----	----
		EP076HK: Fluoranthene	206-44-0	250 µg/kg	55.3	----	50.0	130	----	----
		EP076HK: Pyrene	129-00-0	250 µg/kg	54.8	----	50.0	130	----	----
		EP076HK: Benz(a)anthracene	56-55-3	250 µg/kg	73.4	----	50.0	130	----	----
		EP076HK: Chrysene	218-01-9	250 µg/kg	64.8	----	50.0	130	----	----
		EP076HK: Benzo(b)fluoranthene	205-99-2	250 µg/kg	81.3	----	50.0	130	----	----
		EP076HK: Benzo(k)fluoranthene	207-08-9	250 µg/kg	76.7	----	50.0	130	----	----
		EP076HK: Benzo(a)pyrene	50-32-8	250 µg/kg	78.3	----	50.0	130	----	----
		EP076HK: Indeno(1.2.3.cd)pyrene	193-39-5	250 µg/kg	79.6	----	50.0	130	----	----
EP076HK: Dibenz(a,h)anthracene	53-70-3	250 µg/kg	77.9	----	50.0	130	----	----		
EP076HK: Benzo(g,h,i)perylene	191-24-2	250 µg/kg	72.3	----	50.0	130	----	----		
EP-076HK: Polycyclic Aromatic Hydrocarbons (PAHs) (QC Lot: 3160526)										
HK2027733-005	BH6-S5	EP076HK: Naphthalene	91-20-3	250 µg/kg	98.2	----	50.0	130	----	----
		EP076HK: Acenaphthylene	208-96-8	250 µg/kg	97.7	----	50.0	130	----	----
		EP076HK: Acenaphthene	83-32-9	250 µg/kg	95.0	----	50.0	130	----	----
		EP076HK: Fluorene	86-73-7	250 µg/kg	96.3	----	50.0	130	----	----
		EP076HK: Phenanthrene	85-01-8	250 µg/kg	97.0	----	50.0	130	----	----
		EP076HK: Anthracene	120-12-7	250 µg/kg	96.5	----	50.0	130	----	----
		EP076HK: Fluoranthene	206-44-0	250 µg/kg	101	----	50.0	130	----	----
		EP076HK: Pyrene	129-00-0	250 µg/kg	99.0	----	50.0	130	----	----
		EP076HK: Benz(a)anthracene	56-55-3	250 µg/kg	96.6	----	50.0	130	----	----



Matrix: SOIL				Matrix Spike (MS) and Matrix Spike Duplicate (MSD) Report							
Laboratory sample ID	Client sample ID	Method: Compound	CAS Number	Spike Concentration	Spike Recovery (%)		Recovery Limits (%)		RPD (%)		
					MS	MSD	Low	High	Value	Control Limit	
EP-076HK: Polycyclic Aromatic Hydrocarbons (PAHs) (QC Lot: 3160526) - Continued											
HK2027733-005	BH6-S5	EP076HK: Chrysene	218-01-9	250 µg/kg	99.2	----	50.0	130	----	----	
		EP076HK: Benzo(b)fluoranthene	205-99-2	250 µg/kg	103	----	50.0	130	----	----	
		EP076HK: Benzo(k)fluoranthene	207-08-9	250 µg/kg	89.8	----	50.0	130	----	----	
		EP076HK: Benzo(a)pyrene	50-32-8	250 µg/kg	100	----	50.0	130	----	----	
		EP076HK: Indeno(1.2.3.cd)pyrene	193-39-5	250 µg/kg	97.0	----	50.0	130	----	----	
		EP076HK: Dibenz(a,h)anthracene	53-70-3	250 µg/kg	94.8	----	50.0	130	----	----	
		EP076HK: Benzo(g,h,i)perylene	191-24-2	250 µg/kg	94.4	----	50.0	130	----	----	
EP-071HK_SR: Total Petroleum Hydrocarbons (TPH) (QC Lot: 3159803)											
HK2027649-001	Anonymous	EP071HK_SR: C9 - C16 Fraction	----	31.5 mg/kg	90.6	----	50.0	130	----	----	
		EP071HK_SR: C17 - C35 Fraction	----	67.5 mg/kg	75.4	----	50.0	130	----	----	
EP-071HK_SR: Total Petroleum Hydrocarbons (TPH) (QC Lot: 3159804)											
HK2027649-001	Anonymous	EP070HK_SR: C6 - C8 Fraction	----	4.5 mg/kg	101	----	50.0	130	----	----	
EP-074_SR-A: Monocyclic Aromatic Hydrocarbons (MAH) (QC Lot: 3151540)											
HK2027136-001	Anonymous	EP074_SR: Benzene	71-43-2	0.25 mg/kg	103	----	50.0	130	----	----	
		EP074_SR: Toluene	108-88-3	0.25 mg/kg	100	----	50.0	130	----	----	
		EP074_SR: Ethylbenzene	100-41-4	0.25 mg/kg	105	----	50.0	130	----	----	
		EP074_SR: meta- & para-Xylene	108-38-3	0.5 mg/kg	105	----	50.0	130	----	----	
			106-42-3								
		EP074_SR: ortho-Xylene	95-47-6	0.25 mg/kg	108	----	50.0	130	----	----	
		EP074_SR: Xylenes (Total)	----	0.75 mg/kg	106	----	50.0	130	----	----	
EP-074_SR-A: Monocyclic Aromatic Hydrocarbons (MAH) (QC Lot: 3160527)											
HK2027733-005	BH6-S5	EP074_SR: Benzene	71-43-2	0.25 mg/kg	87.6	----	50.0	130	----	----	
		EP074_SR: Toluene	108-88-3	0.25 mg/kg	87.8	----	50.0	130	----	----	
		EP074_SR: Ethylbenzene	100-41-4	0.25 mg/kg	102	----	50.0	130	----	----	
		EP074_SR: meta- & para-Xylene	108-38-3	0.5 mg/kg	101	----	50.0	130	----	----	
			106-42-3								
		EP074_SR: ortho-Xylene	95-47-6	0.25 mg/kg	101	----	50.0	130	----	----	
		EP074_SR: Xylenes (Total)	----	0.75 mg/kg	101	----	50.0	130	----	----	
EP-074_SR-I: Methyl-tert-butyl Ether (QC Lot: 3151540)											



Matrix: SOIL				Matrix Spike (MS) and Matrix Spike Duplicate (MSD) Report						
Laboratory sample ID	Client sample ID	Method: Compound	CAS Number	Spike Concentration	Spike Recovery (%)		Recovery Limits (%)		RPD (%)	
					MS	MSD	Low	High	Value	Control Limit
EP-074_SR-I: Methyl-tert-butyl Ether (QC Lot: 3151540) - Continued										
HK2027136-001	Anonymous	EP074_SR: Methyl tert-Butyl Ether (MTBE)	1634-04-4	0.25 mg/kg	113	----	50.0	130	----	----
EP-074_SR-I: Methyl-tert-butyl Ether (QC Lot: 3160527)										
HK2027733-005	BH6-S5	EP074_SR: Methyl tert-Butyl Ether (MTBE)	1634-04-4	0.25 mg/kg	82.0	----	50.0	130	----	----

Surrogate Control Limits

Sub-Matrix: SOIL		Recovery Limits (%)	
Compound	CAS Number	Low	High
EP-076S: Polycyclic Aromatics Hydrocarbons (PAHs) Surrogates			
2-Fluorobiphenyl	321-60-8	50	130
4-Terphenyl-d14	1718-51-0	50	130
EP-080_SRS: TPH(Volatile)/BTEX Surrogate			
Dibromofluoromethane	1868-53-7	80	120
Toluene-D8	2037-26-5	81	117
4-Bromofluorobenzene	460-00-4	74	121
EP-074_SR-S: VOC Surrogates			
Dibromofluoromethane	1868-53-7	80	120
Toluene-D8	2037-26-5	81	117
4-Bromofluorobenzene	460-00-4	74	121

Sub-Matrix: WATER		Recovery Limits (%)	
Compound	CAS Number	Low	High
EP-080_SRS: TPH(Volatile)/BTEX Surrogate			
Dibromofluoromethane	1868-53-7	86	118
Toluene-D8	2037-26-5	88	110
4-Bromofluorobenzene	460-00-4	86	115
EP-074_SR-S: VOC Surrogates			
Dibromofluoromethane	1868-53-7	86	118



Sub-Matrix: WATER		Recovery Limits (%)	
Compound	CAS Number	Low	High
EP-074_SR-S: VOC Surrogates - Continued			
Toluene-D8	2037-26-5	88	110
4-Bromofluorobenzene	460-00-4	86	115





CERTIFICATE OF ANALYSIS

Client	: MOTT MACDONALD HONG KONG LIMITED	Laboratory	: ALS Technichem (HK) Pty Ltd	Page	: 1 of 12
Contact	: THOMAS CHAN	Contact	: Richard Fung	Work Order	: HK2031443
Address	: 3/F INTERNATIONAL TRADE TOWER, 348 KWUN TONG ROAD, KWUN TONG, KOWLOON, HONG KONG	Address	: 11/F., Chung Shun Knitting Centre, 1 - 3 Wing Yip Street, Kwai Chung, N.T., Hong Kong		
E-mail	: thomas.chan@mottmac.com	E-mail	: richard.fung@alsglobal.com	Date Samples Received	: 20-Aug-2020
Telephone	: +852 2828 5933	Telephone	: +852 2610 1044	Issue Date	: 31-Aug-2020
Facsimile	: +852 2828 1823	Facsimile	: +852 2610 2021	No. of samples received	: 3
Project	: SOIL TESTING AT HONG KONG AIRPORT			No. of samples analysed	: 3
Order number	: ---	Quote number	: HKE/1861c/2018_V2		
C-O-C number	: H030966				
Site	: CONTRACT NO. C3503 TERMINAL 2 FOUNDATION AND SUBSTRUCTURE WORKS				

This report may not be reproduced except with prior written approval from the testing laboratory.

Hong Kong Accreditation Service (HKAS) has accredited this laboratory, ALS Technichem (HK) Pty Ltd (Reg. No. HOKLAS 066) under Hong Kong Laboratory Accreditation Scheme (HOKLAS) for specific laboratory activities as listed in the HOKLAS Directory of Accredited Laboratories.

This document has been signed by those names that appear on this report and are the authorised signatories.

Signatories	Position	Authorised results for
 Anh Ngoc Huynh .	Senior Chemist	Organics_ENV
 Chan Siu Ming , Vico	Manager - Inorganics	Inorganics
 Wong Wing , Kenneth	Manager - Metals	Metals_ENV



General Comments

This report supersedes any previous report(s) with this reference. All pages of this report have been checked and approved for release. When sampling time information is not provided by the client, sampling dates are shown without a time component. In these instances, the time component has been assumed by the laboratory for processing purposes. Testing period is from 20-Aug-2020 to 31-Aug-2020.

Key: LOR = Limit of reporting; CAS Number = CAS registry number from database maintained by Chemical Abstracts Services. The Chemical Abstracts Service is a division of the American Chemical Society.

Specific Comments for Work Order: HK2031443

Sample(s) was/ were submitted by client. Sample(s) arrived laboratory in chilled condition. The result(s) related only to the item(s) tested.

Sample information (Project name, Sample ID, Sampling date/time, etc., if any) is provided by client.

Result(s) of soil/sediment sample(s) was / were reported on dry weight basis.

EP070 is the numeric code for internal use. Test method for C6-C9 Fraction of TPH is EP071.

Sample(s) as received, digested by In-house method E-ASTM D3974-09 prior to determination of metals. The In-house method is developed based on ASTM D3974-09 method.



Analytical Results

Sub-Matrix: SOIL

Client sample ID

Client sampling date / time

				BH5-1000B2NDS	BH5-UNDERS500	---	---	---
				20-Aug-2020	20-Aug-2020	---	---	---
Compound	CAS Number	LOR	Unit	HK2031443-002	HK2031443-003	-----	-----	-----
EA/ED: Physical and Aggregate Properties								
EA055: Moisture Content (dried @ 103°C)	----	0.1	%	18.9	17.6	---	---	---
EG: Metals and Major Cations								
EG020: Lead	7439-92-1	1	mg/kg	4	7	---	---	---
EP-076HK: Polycyclic Aromatic Hydrocarbons (PAHs)								
EP076HK: Naphthalene	91-20-3	0.500	mg/kg	<0.500	<0.500	---	---	---
EP076HK: Acenaphthylene	208-96-8	0.500	mg/kg	<0.500	<0.500	---	---	---
EP076HK: Acenaphthene	83-32-9	0.500	mg/kg	<0.500	<0.500	---	---	---
EP076HK: Fluorene	86-73-7	0.500	mg/kg	<0.500	<0.500	---	---	---
EP076HK: Phenanthrene	85-01-8	0.500	mg/kg	<0.500	<0.500	---	---	---
EP076HK: Anthracene	120-12-7	0.500	mg/kg	<0.500	<0.500	---	---	---
EP076HK: Fluoranthene	206-44-0	0.500	mg/kg	<0.500	<0.500	---	---	---
EP076HK: Pyrene	129-00-0	0.500	mg/kg	<0.500	<0.500	---	---	---
EP076HK: Benz(a)anthracene	56-55-3	0.500	mg/kg	<0.500	<0.500	---	---	---
EP076HK: Chrysene	218-01-9	0.500	mg/kg	<0.500	<0.500	---	---	---
EP076HK: Benzo(b)fluoranthene	205-99-2	0.500	mg/kg	<0.500	<0.500	---	---	---
EP076HK: Benzo(k)fluoranthene	207-08-9	0.500	mg/kg	<0.500	<0.500	---	---	---
EP076HK: Benzo(a)pyrene	50-32-8	0.500	mg/kg	<0.500	<0.500	---	---	---
EP076HK: Indeno(1.2.3.cd)pyrene	193-39-5	0.500	mg/kg	<0.500	<0.500	---	---	---
EP076HK: Dibenz(a,h)anthracene	53-70-3	0.500	mg/kg	<0.500	<0.500	---	---	---
EP076HK: Benzo(g,h,i)perylene	191-24-2	0.500	mg/kg	<0.500	<0.500	---	---	---
EP-071HK_SR: Total Petroleum Hydrocarbons (TPH)								
EP070HK_SR: C6 - C8 Fraction	----	5	mg/kg	<5	<5	---	---	---
EP071HK_SR: C9 - C16 Fraction	----	200	mg/kg	<200	<200	---	---	---
EP071HK_SR: C17 - C35 Fraction	----	500	mg/kg	<500	<500	---	---	---
EP-074_SR-A: Monocyclic Aromatic Hydrocarbons (MAH)								
EP074_SR: Benzene	71-43-2	0.2	mg/kg	<0.2	<0.2	---	---	---
EP074_SR: Toluene	108-88-3	0.5	mg/kg	<0.5	<0.5	---	---	---
EP074_SR: Ethylbenzene	100-41-4	0.5	mg/kg	<0.5	<0.5	---	---	---



Sub-Matrix: SOIL				Client sample ID	BH5-1000B2NDS	BH5-UNDERS500	---	---	---
				Client sampling date / time	20-Aug-2020	20-Aug-2020	---	---	---
Compound	CAS Number	LOR	Unit	HK2031443-002	HK2031443-003	---	---	---	
EP-074_SR-A: Monocyclic Aromatic Hydrocarbons (MAH) - Continued									
EP074_SR: meta- & para-Xylene	108-38-3	1.0	mg/kg	<1.0	<1.0	---	---	---	
	106-42-3								
EP074_SR: ortho-Xylene	95-47-6	0.5	mg/kg	<0.5	<0.5	---	---	---	
EP074_SR: Xylenes (Total)	----	2.0	mg/kg	<2.0	<2.0	---	---	---	
EP-074_SR-I: Methyl-tert-butyl Ether									
EP074_SR: Methyl tert-Butyl Ether (MTBE)	1634-04-4	0.2	mg/kg	<0.2	<0.2	---	---	---	
EP-076S: Polycyclic Aromatics Hydrocarbons (PAHs) Surrogates									
EP076HK: 2-Fluorobiphenyl	321-60-8	0.1	%	95.2	100.0	---	---	---	
EP076HK: 4-Terphenyl-d14	1718-51-0	0.1	%	90.5	97.7	---	---	---	
EP-080_SRS: TPH(Volatile)/BTEX Surrogate									
EP070HK_SR: Dibromofluoromethane	1868-53-7	0.1	%	92.2	91.7	---	---	---	
EP070HK_SR: Toluene-D8	2037-26-5	0.1	%	104	107	---	---	---	
EP070HK_SR: 4-Bromofluorobenzene	460-00-4	0.1	%	91.6	95.4	---	---	---	
EP-074_SR-S: VOC Surrogates									
EP074_SR: Dibromofluoromethane	1868-53-7	0.1	%	92.2	91.7	---	---	---	
EP074_SR: Toluene-D8	2037-26-5	0.1	%	104	107	---	---	---	
EP074_SR: 4-Bromofluorobenzene	460-00-4	0.1	%	91.6	95.4	---	---	---	



Sub-Matrix: WATER				Client sample ID	Trip Blank	---	---	---	---
				Client sampling date / time	20-Aug-2020	---	---	---	---
Compound	CAS Number	LOR	Unit	HK2031443-001	---	---	---	---	---
EP-071HK_SR: Total Petroleum Hydrocarbons (TPH)									
EP070HK_SR: C6 - C8 Fraction	----	20	µg/L	<20	---	---	---	---	---
EP-074_SR-A: Monocyclic Aromatic Hydrocarbons (MAH)									
EP074_SR: Benzene	71-43-2	5.0	µg/L	<5.0	---	---	---	---	---
EP074_SR: Toluene	108-88-3	5.0	µg/L	<5.0	---	---	---	---	---
EP074_SR: Ethylbenzene	100-41-4	5.0	µg/L	<5.0	---	---	---	---	---
EP074_SR: meta- & para-Xylene	108-38-3 106-42-3	10	µg/L	<10	---	---	---	---	---
EP074_SR: ortho-Xylene	95-47-6	5.0	µg/L	<5.0	---	---	---	---	---
EP074_SR: Xylenes (Total)	----	20	µg/L	<20	---	---	---	---	---
EP-074_SR-I: Methyl-tert-butyl Ether									
EP074_SR: Methyl tert-Butyl Ether (MTBE)	1634-04-4	0.5	µg/L	<0.5	---	---	---	---	---
EP-080_SRS: TPH(Volatile)/BTEX Surrogate									
EP070HK_SR: Dibromofluoromethane	1868-53-7	0.1	%	107	---	---	---	---	---
EP070HK_SR: Toluene-D8	2037-26-5	0.1	%	106	---	---	---	---	---
EP070HK_SR: 4-Bromofluorobenzene	460-00-4	0.1	%	91.6	---	---	---	---	---
EP-074_SR-S: VOC Surrogates									
EP074_SR: Dibromofluoromethane	1868-53-7	0.1	%	107	---	---	---	---	---
EP074_SR: Toluene-D8	2037-26-5	0.1	%	106	---	---	---	---	---
EP074_SR: 4-Bromofluorobenzene	460-00-4	0.1	%	91.6	---	---	---	---	---



Laboratory Duplicate (DUP) Report

Matrix: SOIL

Laboratory Duplicate (DUP) Report

Laboratory sample ID	Client sample ID	Method: Compound	CAS Number	LOR	Unit	Original Result	Duplicate Result	RPD (%)
EA/ED: Physical and Aggregate Properties (QC Lot: 3217901)								
HK2031199-001	Anonymous	EA055: Moisture Content (dried @ 103°C)	----	0.1	%	22.6	22.3	1.60
HK2031596-001	Anonymous	EA055: Moisture Content (dried @ 103°C)	----	0.1	%	31.6	32.2	1.82
EG: Metals and Major Cations (QC Lot: 3212907)								
HK2031404-001	Anonymous	EG020: Lead	7439-92-1	1	mg/kg	51	44	15.8
EP-076HK: Polycyclic Aromatic Hydrocarbons (PAHs) (QC Lot: 3210491)								
HK2031185-001	Anonymous	EP076HK: Naphthalene	91-20-3	50	µg/kg	<0.500 mg/kg	<500	0.00
		EP076HK: Acenaphthylene	208-96-8	50	µg/kg	<0.500 mg/kg	<500	0.00
		EP076HK: Acenaphthene	83-32-9	50	µg/kg	<0.500 mg/kg	<500	0.00
		EP076HK: Fluorene	86-73-7	50	µg/kg	<0.500 mg/kg	<500	0.00
		EP076HK: Phenanthrene	85-01-8	50	µg/kg	<0.500 mg/kg	<500	0.00
		EP076HK: Anthracene	120-12-7	50	µg/kg	<0.500 mg/kg	<500	0.00
		EP076HK: Fluoranthene	206-44-0	50	µg/kg	<0.500 mg/kg	<500	0.00
		EP076HK: Pyrene	129-00-0	50	µg/kg	<0.500 mg/kg	<500	0.00
		EP076HK: Benz(a)anthracene	56-55-3	50	µg/kg	<0.500 mg/kg	<500	0.00
		EP076HK: Chrysene	218-01-9	50	µg/kg	<0.500 mg/kg	<500	0.00
		EP076HK: Benzo(b)fluoranthene	205-99-2	50	µg/kg	<0.500 mg/kg	<500	0.00
		EP076HK: Benzo(k)fluoranthene	207-08-9	50	µg/kg	<0.500 mg/kg	<500	0.00
		EP076HK: Benzo(a)pyrene	50-32-8	50	µg/kg	<0.500 mg/kg	<500	0.00
		EP076HK: Indeno(1.2.3.cd)pyrene	193-39-5	50	µg/kg	<0.500 mg/kg	<500	0.00
EP076HK: Dibenz(a,h)anthracene	53-70-3	50	µg/kg	<0.500 mg/kg	<500	0.00		
EP076HK: Benzo(g,h,i)perylene	191-24-2	50	µg/kg	<0.500 mg/kg	<500	0.00		
EP-071HK_SR: Total Petroleum Hydrocarbons (TPH) (QC Lot: 3215762)								
HK2031199-001	Anonymous	EP071HK_SR: C9 - C16 Fraction	----	200	mg/kg	<200	<200	0.00
		EP071HK_SR: C17 - C35 Fraction	----	500	mg/kg	<500	<500	0.00
EP-071HK_SR: Total Petroleum Hydrocarbons (TPH) (QC Lot: 3215763)								
HK2031199-001	Anonymous	EP070HK_SR: C6 - C8 Fraction	----	5	mg/kg	<5	<5	0.00
EP-074_SR-A: Monocyclic Aromatic Hydrocarbons (MAH) (QC Lot: 3204956)								
HK2031051-001	Anonymous	EP074_SR: Benzene	71-43-2	0.1	mg/kg	<0.2	<0.2	0.00
		EP074_SR: Toluene	108-88-3	0.2	mg/kg	<0.5	<0.5	0.00
		EP074_SR: Ethylbenzene	100-41-4	0.2	mg/kg	<0.5	<0.5	0.00



Matrix: SOIL				Laboratory Duplicate (DUP) Report				
Laboratory sample ID	Client sample ID	Method: Compound	CAS Number	LOR	Unit	Original Result	Duplicate Result	RPD (%)
EP-074_SR-A: Monocyclic Aromatic Hydrocarbons (MAH) (QC Lot: 3204956) - Continued								
HK2031051-001	Anonymous	EP074_SR: ortho-Xylene	95-47-6	0.2	mg/kg	<0.5	<0.5	0.00
		EP074_SR: meta- & para-Xylene	108-38-3 106-42-3	0.4	mg/kg	<1.0	<1.0	0.00
		EP074_SR: Xylenes (Total)	----	1	mg/kg	<2.0	<2.0	0.00
EP-074_SR-I: Methyl-tert-butyl Ether (QC Lot: 3204956)								
HK2031051-001	Anonymous	EP074_SR: Methyl tert-Butyl Ether (MTBE)	1634-04-4	0.2	mg/kg	<0.5	<0.5	0.00

Method Blank (MB), Laboratory Control Spike (LCS) and Laboratory Control Spike Duplicate (DCS) Report

Matrix: SOIL				Method Blank (MB) Report			Laboratory Control Spike (LCS) and Laboratory Control Spike Duplicate (DCS) Report					
Method: Compound	CAS Number	LOR	Unit	Result	Spike Concentration	Spike Recovery (%)		Recovery Limits(%)		RPD (%)		
						LCS	DCS	Low	High	Value	Control Limit	
EG: Metals and Major Cations (QC Lot: 3212907)												
EG020: Lead	7439-92-1	1	mg/kg	<1	5 mg/kg	106	----	90.0	110	----	----	
EP-076HK: Polycyclic Aromatic Hydrocarbons (PAHs) (QC Lot: 3210491)												
EP076HK: Naphthalene	91-20-3	50	µg/kg	<50	25 µg/kg	116	----	54.0	138	----	----	
EP076HK: Acenaphthylene	208-96-8	50	µg/kg	<50	25 µg/kg	122	----	56.0	145	----	----	
EP076HK: Acenaphthene	83-32-9	50	µg/kg	<50	25 µg/kg	111	----	54.0	139	----	----	
EP076HK: Fluorene	86-73-7	50	µg/kg	<50	25 µg/kg	114	----	54.0	140	----	----	
EP076HK: Phenanthrene	85-01-8	50	µg/kg	<50	25 µg/kg	113	----	51.0	139	----	----	
EP076HK: Anthracene	120-12-7	50	µg/kg	<50	25 µg/kg	117	----	54.0	145	----	----	
EP076HK: Fluoranthene	206-44-0	50	µg/kg	<50	25 µg/kg	118	----	55.0	142	----	----	
EP076HK: Pyrene	129-00-0	50	µg/kg	<50	25 µg/kg	116	----	52.0	141	----	----	
EP076HK: Benz(a)anthracene	56-55-3	50	µg/kg	<50	25 µg/kg	120	----	48.0	142	----	----	
EP076HK: Chrysene	218-01-9	50	µg/kg	<50	25 µg/kg	113	----	49.0	146	----	----	
EP076HK: Benzo(b)fluoranthene	205-99-2	50	µg/kg	<50	25 µg/kg	101	----	46.0	130	----	----	
EP076HK: Benzo(k)fluoranthene	207-08-9	50	µg/kg	<50	25 µg/kg	91.6	----	42.0	139	----	----	
EP076HK: Benzo(a)pyrene	50-32-8	50	µg/kg	<50	25 µg/kg	82.5	----	26.0	140	----	----	
EP076HK: Indeno(1.2.3.cd)pyrene	193-39-5	50	µg/kg	<50	25 µg/kg	53.6	----	25.0	126	----	----	
EP076HK: Dibenz(a.h)anthracene	53-70-3	50	µg/kg	<50	25 µg/kg	54.9	----	27.0	130	----	----	
EP076HK: Benzo(g,h,i)perylene	191-24-2	50	µg/kg	<50	25 µg/kg	49.8	----	15.0	138	----	----	



Matrix: SOIL		Method Blank (MB) Report			Laboratory Control Spike (LCS) and Laboratory Control Spike Duplicate (DCS) Report						
Method: Compound	CAS Number	LOR	Unit	Result	Spike Concentration	Spike Recovery (%)		Recovery Limits(%)		RPD (%)	
						LCS	DCS	Low	High	Value	Control Limit
EP-071HK_SR: Total Petroleum Hydrocarbons (TPH) (QC Lot: 3215762)											
EP071HK_SR: C9 - C16 Fraction	----	200	mg/kg	<200	31.5 mg/kg	95.5	----	79.0	102	----	----
EP071HK_SR: C17 - C35 Fraction	----	500	mg/kg	<500	67.5 mg/kg	73.9	----	59.0	101	----	----
EP-071HK_SR: Total Petroleum Hydrocarbons (TPH) (QC Lot: 3215763)											
EP070HK_SR: C6 - C8 Fraction	----	5	mg/kg	<5	4.5 mg/kg	105	----	77.0	124	----	----
EP-074_SR-A: Monocyclic Aromatic Hydrocarbons (MAH) (QC Lot: 3204956)											
EP074_SR: Benzene	71-43-2	0.1	mg/kg	<0.1	0.25 mg/kg	111	----	80.0	123	----	----
EP074_SR: Toluene	108-88-3	0.2	mg/kg	<0.2	0.25 mg/kg	109	----	83.0	126	----	----
EP074_SR: Ethylbenzene	100-41-4	0.2	mg/kg	<0.2	0.25 mg/kg	95.6	----	80.0	125	----	----
EP074_SR: meta- & para-Xylene	108-38-3 106-42-3	0.4	mg/kg	<0.4	0.5 mg/kg	96.5	----	82.0	124	----	----
EP074_SR: ortho-Xylene	95-47-6	0.2	mg/kg	<0.2	0.25 mg/kg	92.2	----	79.0	128	----	----
EP074_SR: Xylenes (Total)	----	1	mg/kg	<1.0	0.75 mg/kg	95.1	----	82.0	124	----	----
EP-074_SR-I: Methyl-tert-butyl Ether (QC Lot: 3204956)											
EP074_SR: Methyl tert-Butyl Ether (MTBE)	1634-04-4	0.2	mg/kg	<0.2	0.25 mg/kg	91.2	----	78.0	126	----	----
Matrix: WATER		Method Blank (MB) Report			Laboratory Control Spike (LCS) and Laboratory Control Spike Duplicate (DCS) Report						
Method: Compound	CAS Number	LOR	Unit	Result	Spike Concentration	Spike Recovery (%)		Recovery Limits(%)		RPD (%)	
						LCS	DCS	Low	High	Value	Control Limit
EP-071HK_SR: Total Petroleum Hydrocarbons (TPH) (QC Lot: 3202565)											
EP070HK_SR: C6 - C8 Fraction	----	0.02	mg/L	<0.02	0.03 mg/L	91.3	----	77.0	120	----	----
EP-074_SR-A: Monocyclic Aromatic Hydrocarbons (MAH) (QC Lot: 3213245)											
EP074_SR: Benzene	71-43-2	0.5	µg/L	<0.5	2 µg/L	107	----	76.0	125	----	----
EP074_SR: Toluene	108-88-3	0.5	µg/L	<0.5	2 µg/L	99.8	----	78.0	126	----	----
EP074_SR: Ethylbenzene	100-41-4	0.5	µg/L	<0.5	2 µg/L	95.3	----	81.0	120	----	----
EP074_SR: meta- & para-Xylene	108-38-3 106-42-3	1	µg/L	<1	4 µg/L	83.4	----	77.0	125	----	----
EP074_SR: ortho-Xylene	95-47-6	0.5	µg/L	<0.5	2 µg/L	92.2	----	77.0	125	----	----
EP074_SR: Xylenes (Total)	----	2	µg/L	<2	6 µg/L	86.4	----	79.0	123	----	----
EP-074_SR-I: Methyl-tert-butyl Ether (QC Lot: 3213245)											



Matrix: WATER		Method Blank (MB) Report			Laboratory Control Spike (LCS) and Laboratory Control Spike Duplicate (DCS) Report						
		LOR	Unit	Result	Spike Concentration	Spike Recovery (%)		Recovery Limits(%)		RPD (%)	
Method: Compound	CAS Number					LCS	DCS	Low	High	Value	Control Limit
EP-074_SR-I: Methyl-tert-butyl Ether (QC Lot: 3213245) - Continued											
EP074_SR: Methyl tert-Butyl Ether (MTBE)	1634-04-4	0.5	µg/L	<0.5	2 µg/L	83.7	----	78.0	128	----	----



Matrix Spike (MS) and Matrix Spike Duplicate (MSD) Report

Matrix: SOIL

					Matrix Spike (MS) and Matrix Spike Duplicate (MSD) Report					
Laboratory sample ID	Client sample ID	Method: Compound	CAS Number	Spike Concentration	Spike Recovery (%)		Recovery Limits (%)		RPD (%)	
					MS	MSD	Low	High	Value	Control Limit
EG: Metals and Major Cations (QC Lot: 3212907)										
HK2031397-001	Anonymous	EG020: Lead	7439-92-1	5 mg/kg	# Not Determined	----	75.0	125	----	----
EP-076HK: Polycyclic Aromatic Hydrocarbons (PAHs) (QC Lot: 3210491)										
HK2031187-001	Anonymous	EP076HK: Naphthalene	91-20-3	250 µg/kg	96.8	----	50.0	130	----	----
		EP076HK: Acenaphthylene	208-96-8	250 µg/kg	101	----	50.0	130	----	----
		EP076HK: Acenaphthene	83-32-9	250 µg/kg	93.1	----	50.0	130	----	----
		EP076HK: Fluorene	86-73-7	250 µg/kg	94.4	----	50.0	130	----	----
		EP076HK: Phenanthrene	85-01-8	250 µg/kg	92.6	----	50.0	130	----	----
		EP076HK: Anthracene	120-12-7	250 µg/kg	95.2	----	50.0	130	----	----
		EP076HK: Fluoranthene	206-44-0	250 µg/kg	95.2	----	50.0	130	----	----
		EP076HK: Pyrene	129-00-0	250 µg/kg	93.6	----	50.0	130	----	----
		EP076HK: Benz(a)anthracene	56-55-3	250 µg/kg	93.2	----	50.0	130	----	----
		EP076HK: Chrysene	218-01-9	250 µg/kg	90.2	----	50.0	130	----	----
		EP076HK: Benzo(b)fluoranthene	205-99-2	250 µg/kg	82.2	----	50.0	130	----	----
		EP076HK: Benzo(k)fluoranthene	207-08-9	250 µg/kg	72.1	----	50.0	130	----	----
		EP076HK: Benzo(a)pyrene	50-32-8	250 µg/kg	67.2	----	50.0	130	----	----
		EP076HK: Indeno(1,2,3.cd)pyrene	193-39-5	250 µg/kg	51.9	----	50.0	130	----	----
EP076HK: Dibenz(a,h)anthracene	53-70-3	250 µg/kg	51.6	----	50.0	130	----	----		
EP076HK: Benzo(g,h,i)perylene	191-24-2	250 µg/kg	51.7	----	50.0	130	----	----		
EP-071HK_SR: Total Petroleum Hydrocarbons (TPH) (QC Lot: 3215762)										
HK2031397-001	Anonymous	EP071HK_SR: C9 - C16 Fraction	----	31.5 mg/kg	86.9	----	50.0	130	----	----
		EP071HK_SR: C17 - C35 Fraction	----	67.5 mg/kg	67.3	----	50.0	130	----	----
EP-071HK_SR: Total Petroleum Hydrocarbons (TPH) (QC Lot: 3215763)										
HK2031397-001	Anonymous	EP070HK_SR: C6 - C8 Fraction	----	4.5 mg/kg	108	----	50.0	130	----	----
EP-074_SR-A: Monocyclic Aromatic Hydrocarbons (MAH) (QC Lot: 3204956)										
HK2031059-001	Anonymous	EP074_SR: Benzene	71-43-2	0.25 mg/kg	118	----	50.0	130	----	----
		EP074_SR: Toluene	108-88-3	0.25 mg/kg	113	----	50.0	130	----	----
		EP074_SR: Ethylbenzene	100-41-4	0.25 mg/kg	114	----	50.0	130	----	----



Matrix: SOIL				<i>Matrix Spike (MS) and Matrix Spike Duplicate (MSD) Report</i>						
Laboratory sample ID	Client sample ID	Method: Compound	CAS Number	Spike Concentration	Spike Recovery (%)		Recovery Limits (%)		RPD (%)	
					MS	MSD	Low	High	Value	Control Limit
EP-074_SR-A: Monocyclic Aromatic Hydrocarbons (MAH) (QC Lot: 3204956) - Continued										
HK2031059-001	Anonymous	EP074_SR: meta- & para-Xylene	108-38-3	0.5 mg/kg	102	----	50.0	130	----	----
			106-42-3							
		EP074_SR: ortho-Xylene	95-47-6	0.25 mg/kg	112	----	50.0	130	----	----
		EP074_SR: Xylenes (Total)	----	0.75 mg/kg	105	----	50.0	130	----	----
EP-074_SR-I: Methyl-tert-butyl Ether (QC Lot: 3204956)										
HK2031059-001	Anonymous	EP074_SR: Methyl tert-Butyl Ether (MTBE)	1634-04-4	0.25 mg/kg	118	----	50.0	130	----	----

Surrogate Control Limits

Sub-Matrix: SOIL		Recovery Limits (%)	
Compound	CAS Number	Low	High
EP-076S: Polycyclic Aromatics Hydrocarbons (PAHs) Surrogates			
2-Fluorobiphenyl	321-60-8	50	130
4-Terphenyl-d14	1718-51-0	50	130
EP-080_SRS: TPH(Volatile)/BTEX Surrogate			
Dibromofluoromethane	1868-53-7	80	120
Toluene-D8	2037-26-5	81	117
4-Bromofluorobenzene	460-00-4	74	121
EP-074_SR-S: VOC Surrogates			
Dibromofluoromethane	1868-53-7	80	120
Toluene-D8	2037-26-5	81	117
4-Bromofluorobenzene	460-00-4	74	121

Sub-Matrix: WATER		Recovery Limits (%)	
Compound	CAS Number	Low	High
EP-080_SRS: TPH(Volatile)/BTEX Surrogate			
Dibromofluoromethane	1868-53-7	86	118
Toluene-D8	2037-26-5	88	110
4-Bromofluorobenzene	460-00-4	86	115



Sub-Matrix: WATER		Recovery Limits (%)	
Compound	CAS Number	Low	High
EP-074_SR-S: VOC Surrogates			
Dibromofluoromethane	1868-53-7	86	118
Toluene-D8	2037-26-5	88	110
4-Bromofluorobenzene	460-00-4	86	115

J. Site Photo Record of Final Inspection

- J.1 Site Photo Record of Final Inspection for EPSS2 BH9 (3000L Above-ground Fuel Tank)**
- J.2 Site Photo Record of Final Inspection for EPSS2 HS1**
- J.3 Site Photo Record of Final Inspection for EPSS3 BH7 (450 L Above-ground Fuel Tank)**
- J.4 Site Photo Record of Final Inspection for EPSS3 BH8 (Above-ground Emergency Generator)**
- J.5 Site Photo Record of Final Inspection for EPSS5 HS4 (Above-ground Fuel Tank) and HS5 (Above-ground Emergency Generator)**

Appendix J1 Site Photo Record of Final Inspection for EPSS2 **BH9** (3000L **Above-ground** Fuel Tank)

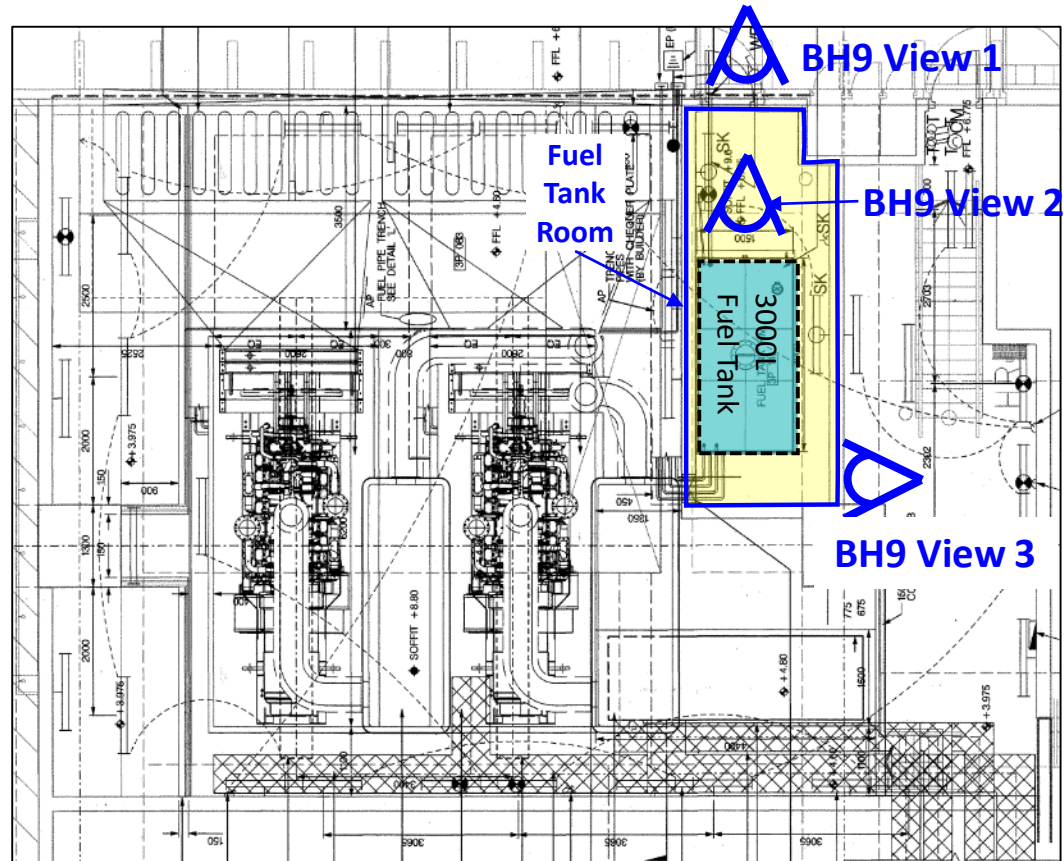

BH9 View 1 - 3000L Above-ground Fuel Tank (BH9)



BH9 View 2 - concrete floor condition underneath 3000L Above-ground Fuel Tank

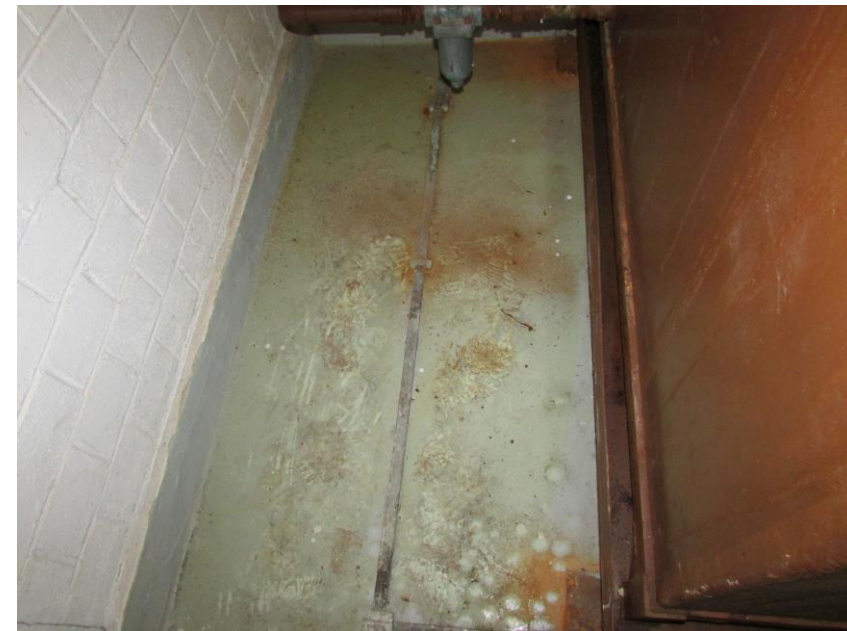

BH9 View 3 - concrete floor condition of fuel tank room with 3000L Above-ground Fuel Tank

Appendix J2 Site Photo Record of Final Inspection for EPSS2 **HS1** (2 **above-ground** Emergency generators connected with 3,000 L **Above-ground** Fuel Tank inside (**BH9**))

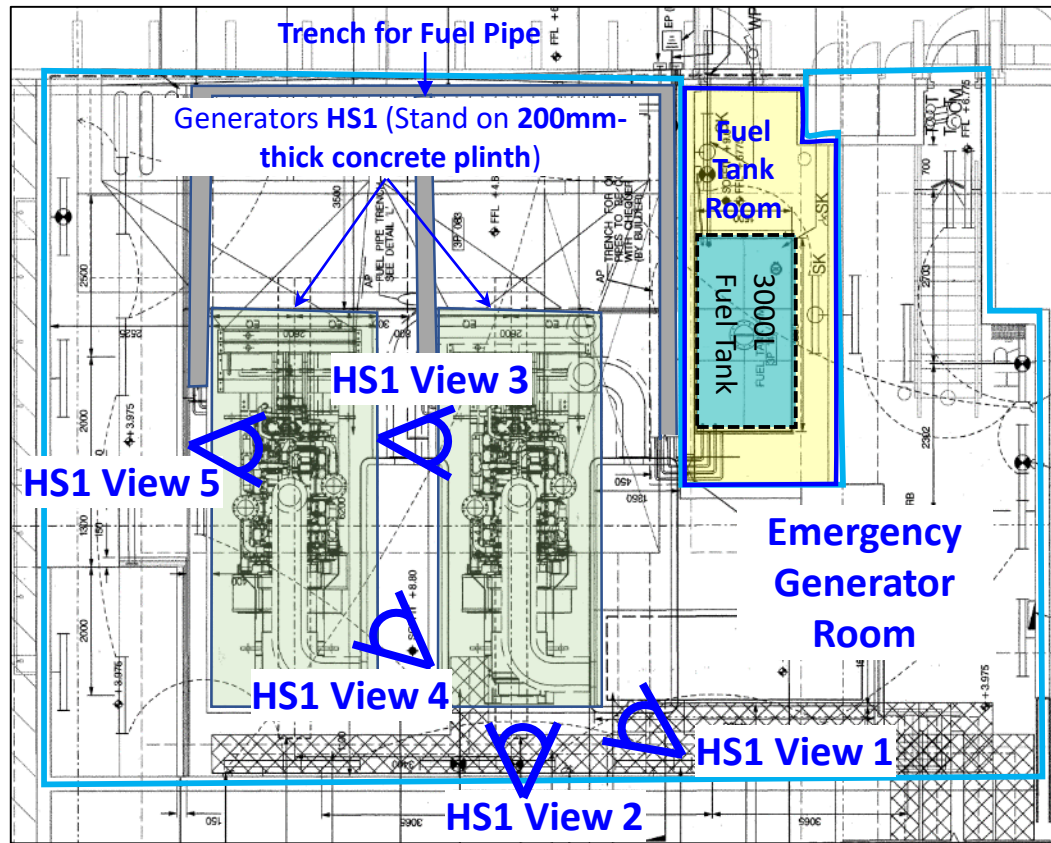

HS1 View 1 - concrete floor condition underneath emergency generators



HS1 View 2 - concrete floor condition underneath emergency generators



HS1 View 3 - concrete floor condition underneath emergency generators



HS1 View 4 - concrete floor condition underneath emergency generators



HS1 View 5 - concrete floor condition underneath emergency generators

Appendix J3 Site Photo Record of Final Inspection for EPSS3 BH7 (450 L Above-ground Fuel Tank)

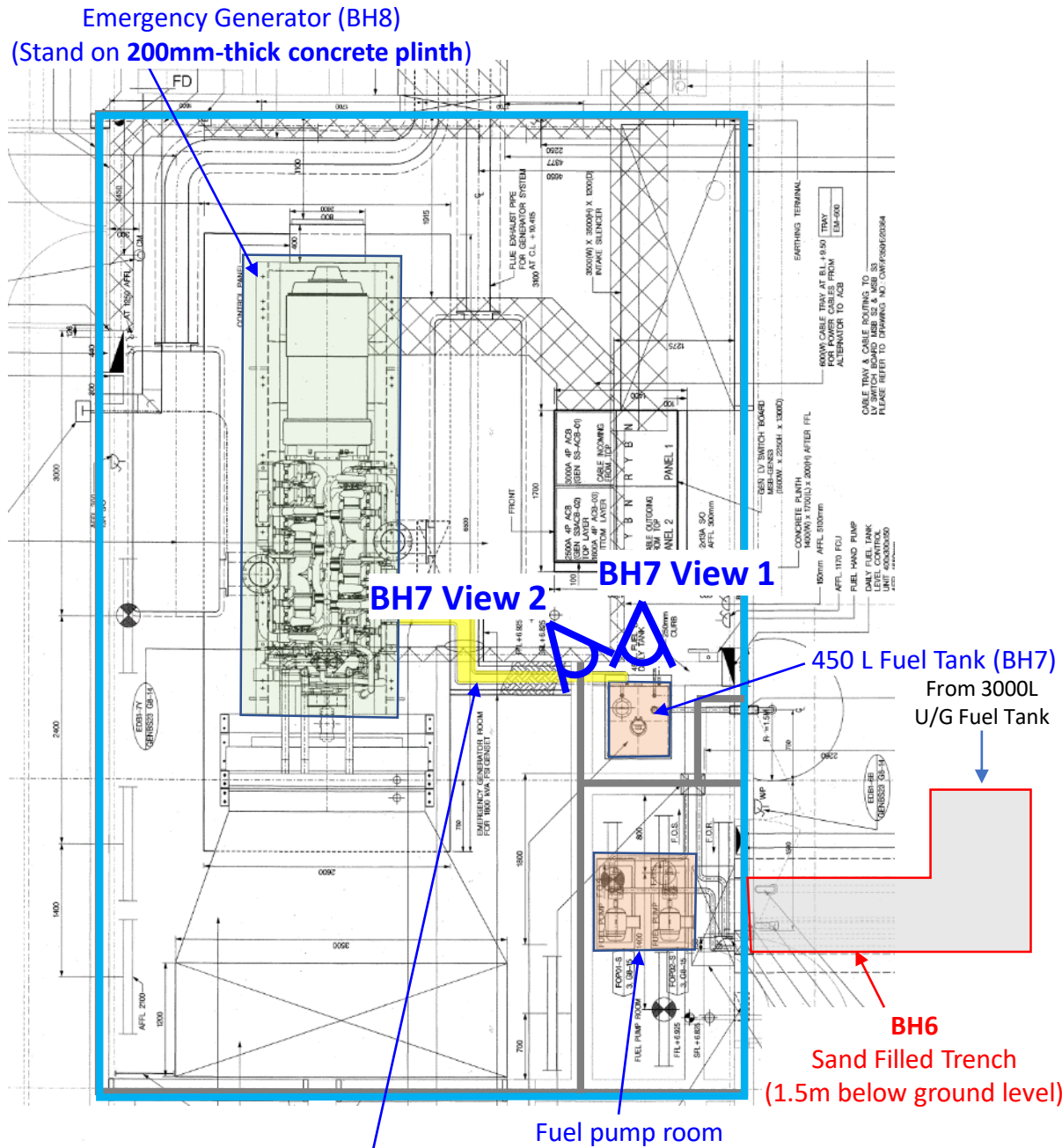

BH7 View 1 - 450 L Above-ground Fuel Tank



BH7 View 2 – Drip tray condition underneath 450 L Above-ground Fuel Tank

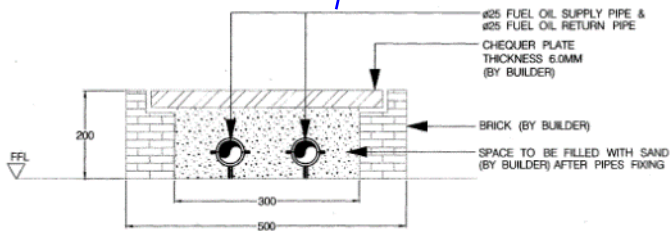

Supply and return pipe from fuel oil tank
(Sand Filled Trench at floor level)

Appendix J4 Site Photo Record of Final Inspection for EPSS3 BH8 (Above-ground Emergency Generator)

Emergency Generator (BH8)
(Stand on 200mm-thick concrete plinth)

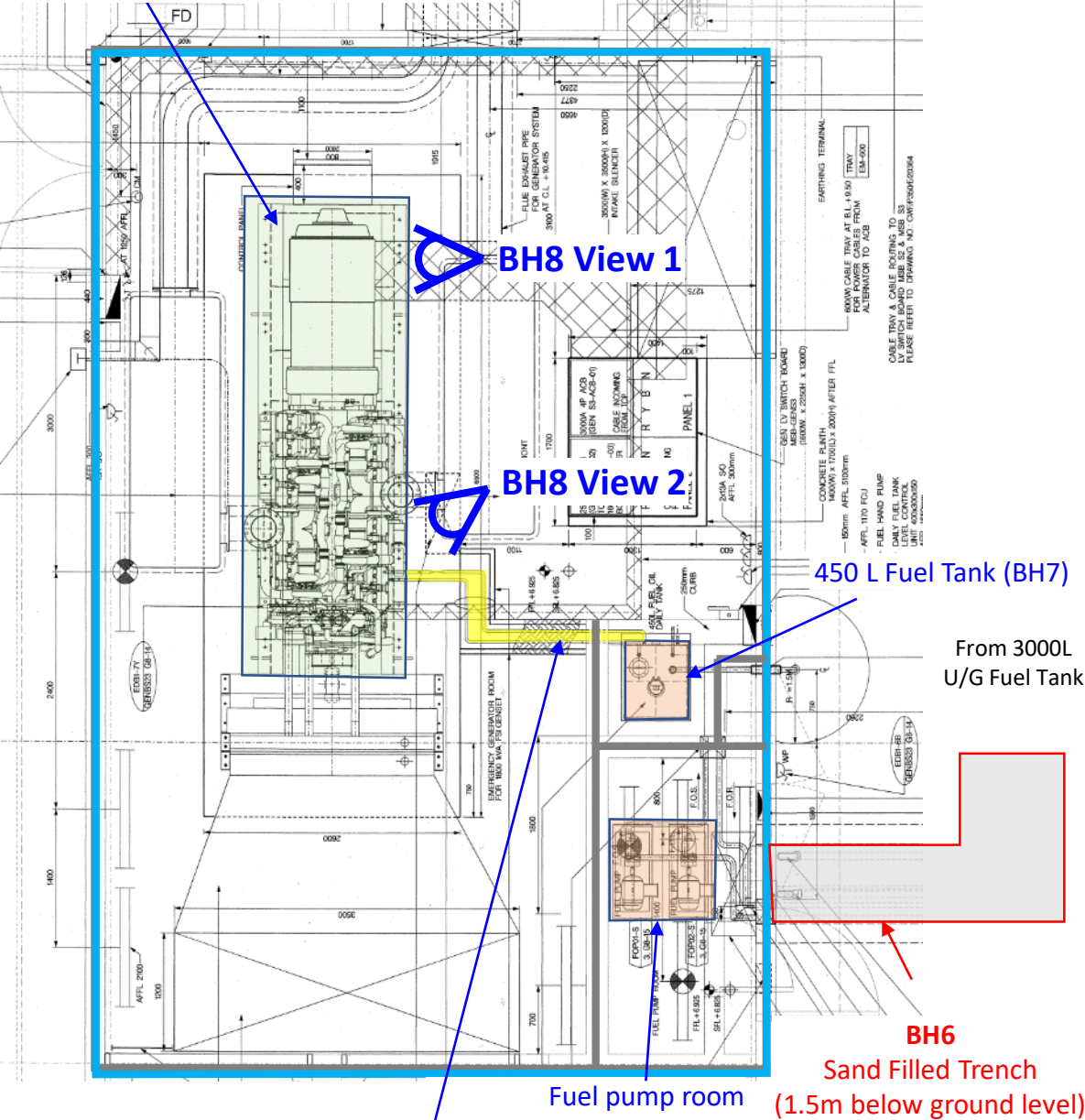

BH8 View 1 - concrete floor condition underneath emergency generator



BH8 View 2 - concrete floor condition underneath emergency generator

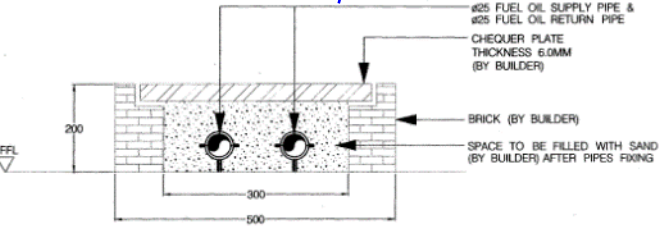

Supply and return pipe from fuel oil tank
(Sand Filled Trench at floor level)

Appendix J5 Site Photo Record of Final Inspection for EPSS5 **HS4** (Above-ground Fuel Tank) and **HS5** (Above-ground Emergency Generator)

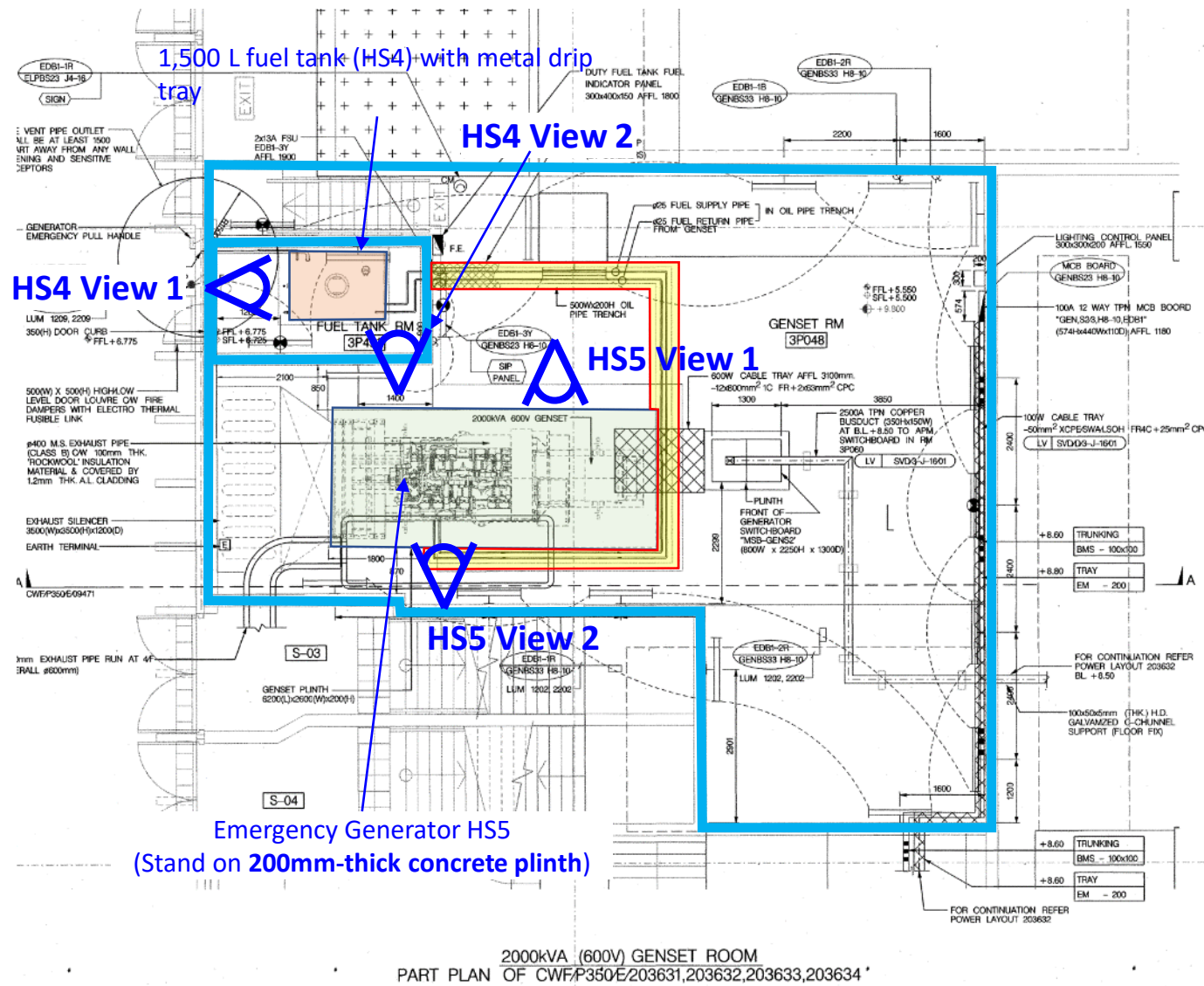

HS4 View 1 - concrete floor condition underneath 1,500L Above-ground Fuel Tank



HS4 View 2 - concrete floor condition of fuel tank room with 1,500 L above-ground fuel tank



HS5 View 1 - concrete floor condition underneath emergency generator



HS5 View 2 - concrete floor condition underneath emergency generator